

KOBELCO

SK330-10/SK350LC-10

SK330 SK350_{LC}



SK350_{LC}

We Save You Fuel
Achieving a Low-Carbon Society

Power Meets Efficiency



SK330 SK350_{LC}

24%
Higher fuel efficiency
means
"Efficiency"

Increase in
productivity
means
"Power"

Compared to S-mode on the SK330-8

To urban centers, and to mines around the world. Kobelco's all-out innovation brings you durable earth-friendly construction machinery that's equal to any task, at sites all over the planet. Increased power and even greater fuel economy bring higher efficiency to any project. Kobelco SK330/SK350LC machines are also more durable than ever, able to withstand the rigors of the toughest job sites. It all adds up to new levels of value that are a step ahead of the times. While focusing on the global environment of the future, Kobelco offers next-generation productivity to meet the need for lower life cycle costs and exceed the expectations of customers the world over.

GENERATION 10



Evolution Continues, with Improved Fuel Efficiency.

In Pursuit of Improved Fuel Efficiency

Operation Mode

Fuel consumption is lower in ECO-mode/S-mode/ H-mode in comparison with the previous model (Generation 8).

■ Compared to previous models



H	H-mode	16%
S	S-mode	19%
E	ECO-mode	24%

Values are approximate improvement rate.

Always and Forever. Yesterday, Today, and Tomorrow. Obsessed with Fuel Efficiency.

Over the past 10 years, Kobelco has achieved an average reduction of about 37% in fuel consumption. And we vow to continue to lead in fuel efficiency.

■ Compared to SK330-6 model (2006)

E ECO-mode (SK330-10)
..... **45%**

Value is approximate improvement rate.

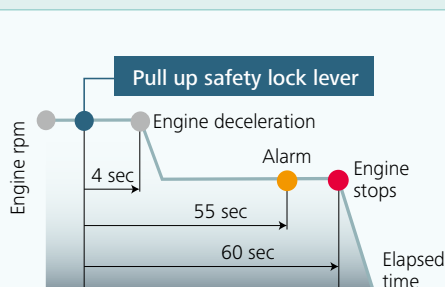

AIS (Auto Idle Stop)

If the boarding/disembarking lever is left up, the engine will stop automatically. This eliminates wasteful idling during standby, saving fuel and reducing CO₂ emissions as well.

24%
Higher fuel efficiency
means
"Efficiency"

The new arm interflow system more efficiently controls hydraulic fluid flow, and significant reduction of in-line resistance and pressure loss boosts fuel efficiency by about 24%*. The electronic-control common-rail engine features high-pressure fuel injection and multiple injection with improved precision. It is fitted with an EGR cooler which greatly reduces PM and NOx emissions, and meets TIERIII Standards.

* Compared to H-mode on the SK330-8



Hydraulic System: Revolutionary Technology Saves Fuel

Arm Interflow System NEW

When lowering the boom, this system uses the downward force generated by the boom's weight to push fluid to the shovel arm. This greatly reduces the need to apply power from outside the system.

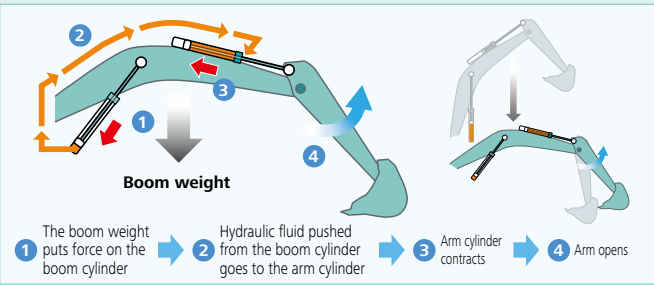

Hydraulic circuit reduces energy loss

We have made every effort to enhance fuel efficiency by minimizing hydraulic pressure resistance, improving the hydraulic line layout to control friction resistance loss and minimizing valve resistance.

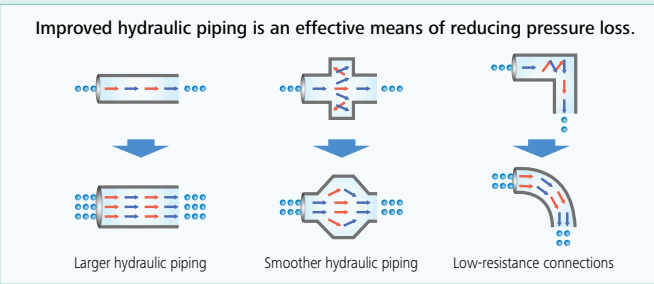

Pursuing maximum fuel efficiency

Common rail system

High-pressure injection atomizes the fuel, and more precise injection improves combustion efficiency. This also contributes to better fuel economy.

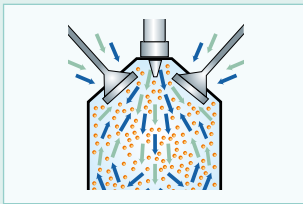

EGR cooler

While ensuring sufficient oxygen for combustion, cooled emission gases are mixed with the intake air and recirculated into the engine. This reduces oxygen content and lowers combustion temperature.

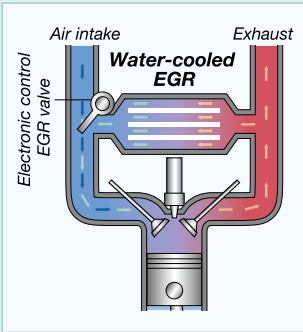

More Power and Higher Efficiency.

The highly efficient hydraulic system minimizes fuel consumption while maximizing power. With nimble movement and ample digging power, this excavator promises to improve your job productivity.

Superior Digging Force

■ Max. Bucket Digging Force

Normal: **222kN**
With power boost: **244kN**

■ Max. Arm Crowding Force

Normal: **163kN**
With power boost: **180kN**

*Values are for HD arm (3.30m)



Get More Done Faster with Superior Operability

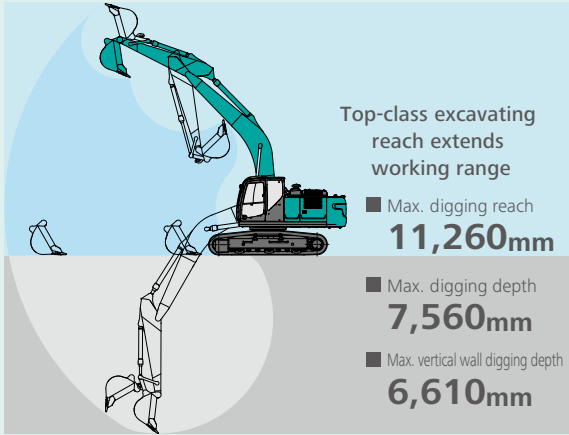

*Values are for HD arm (3.30m)

Piping for Quick Hitch

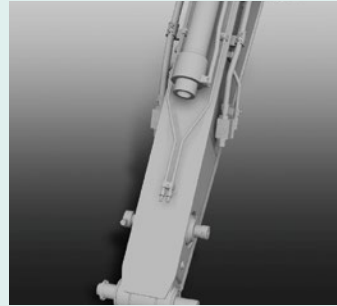

A quick hitch hydraulic line, which speeds up attachment changes, is fitted as standard.

A Light Touch on the Lever Means Smoother, Less Tiring Work **NEW**



It takes 38% less effort to work the operation lever, which reduces fatigue over long working hours or continued operations.



Heavy Lift

10% more hydraulic pressure (Heavy Lift) means greater lifting power, at close radius, allowing for smooth and steady operation while moving heavy objects.



Top Class Traveling Force

Powerful traveling force and pulling force deliver plenty of speed when climbing slopes or negotiating bad roads, and the agility to change direction swiftly and smoothly.

■ Drawbar Pulling Force: **333kN**

Operator-friendly Features Include Controls that Are Easy to See, Easy to Use



Multi-Display in Color

Brilliant colors and graphic displays are easy to recognize on the LCD multi-display in the console. The display shows fuel consumption, maintenance intervals, and more.

- 1 Analog gauge provides an intuitive reading of fuel level and engine water temperature
- 2 Green indicator light shows low fuel consumption during operation
- 3 Fuel consumption/Switch indicator for rear camera images
- 4 Digging mode switch
- 5 Monitor display switch

One-Touch Attachment Mode Switch

A simple flick of a switch converts the hydraulic circuit and flow amount to match attachment changes. Icons help the operator to confirm the proper configuration at a glance.

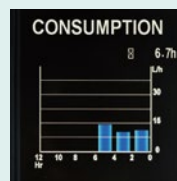

	INTERNAL	EXCHANGE
ENGINE OIL	500	495
FUEL FILTER	500	495
HYD. FILTER	1000	995
HYD. OIL	5000	4995

Maintenance

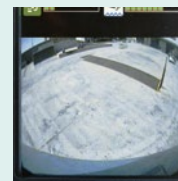
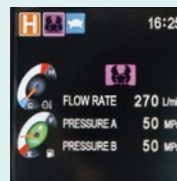
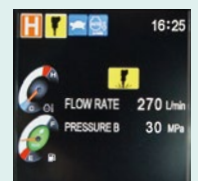

Increased Power, with Enhanced Durability to Maintain the Machine's Value

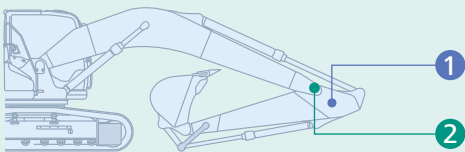

Built to Operate in Tough Working Environments

The attachment has been reinforced to handle a higher work volume, with greater power and excellent durability that can withstand demanding work conditions.

1 Enlarged Reinforcement of the Arm Foot

HD: Base plate thickness has been increased.

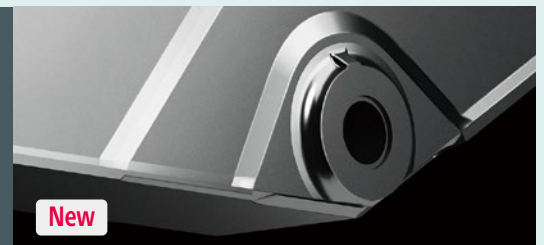

2 Modified Foot Boss Shape

The arm foot boss shape has been modified and improved to distribute stress, delivering more strength for tasks like digging next to a wall.

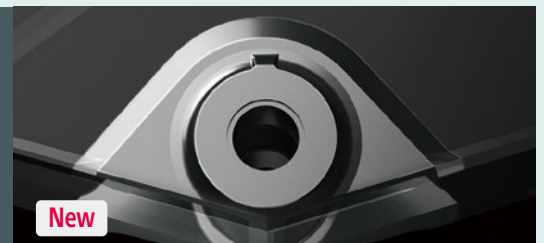

Increase in productivity means "Power"

Structural design increases strength, while eliminating hydraulic problems. Enhanced durability takes productivity to a new level.



Improved Filtration System Reliability

Clean, contaminant-free fuel and hydraulic fluid are essential to stable performance. The improved filtration systems reduce the risk of mechanical trouble and enhance longevity and durability.

Hydraulic Fluid Filter NEW

Recognized as the best in the industry, our super-fine filter separates out even the smallest particles. New cover prevents contamination when changing filters.



Hydraulic Fluid Filter Clog Detector NEW

Pressure sensors at the inlet and outlet of the hydraulic fluid filter monitor differences in pressure to determine the degree of clogging. If the difference in pressure exceeds a predetermined level, a warning appears on the multi-display, so any contamination can be removed from the filter before it reaches the hydraulic fluid reservoir.

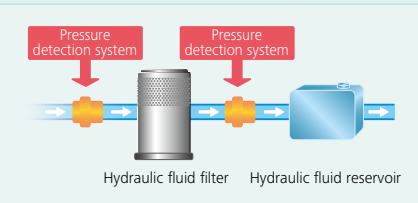

Metal mesh cover air cleaner NEW

Metal mesh cover ensures strength and durability.



Fuel filter

The pre-filter with built-in water-separator has 1.6 times more filter area compared to the previous models, with a new final stage to maximize filtering performance.

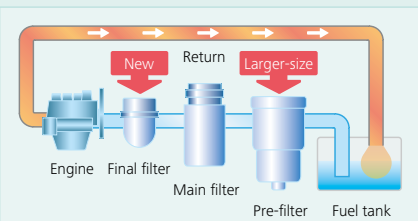

Comfortable Cab Is Now Safer than Ever.

A work environment that is quieter and more comfortable. A cab that puts the operator first is key to improved safety.



The picture is optional air suspension seat.



Comfort

Super-Airtight Cab



The high level of air-tightness keeps dust out of the cab.

Quiet Inside

The high level of air-tightness ensures a quiet, comfortable cabin interior.

Low Vibration

Coil springs absorb small vibrations, and high suspension mounts filled with silicone oil reduce heavy vibration. The long stroke achieved by this system provides excellent protection from vibration.

Twice the stroke of a conventional mount

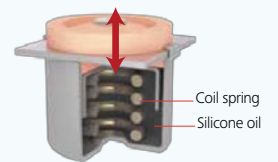

Broad View Liberates the Operator

The front window features one large piece of glass without a center pillar on the right side for a wide, unobstructed view.

Air Conditioner Register behind the Seat

NEW

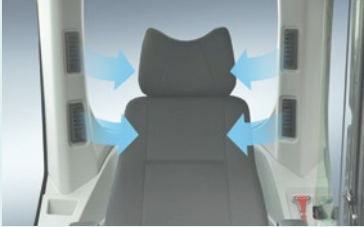

The large air-conditioner has registers on the back pillars that blow from behind and to the right and left of the operator's seat. They can be adjusted to put a direct flow of cool/warm air on the operator, which means a more comfortable operating environment.

More Comfortable Seat Means Higher Productivity



Seat suspension absorbs vibration



Seat recliner can be pushed back flat



Double slides allow adjustment for optimum comfort



Large Cab Is Easy to Get in and out of

The expanded cab provides plenty of room for a large door, more headroom and smoother entry and exit.

Interior Equipment Adds to Comfort and Convenience



AM/FM Bluetooth®(hands-free) radio



USB pin/12V power outlet



Spacious storage tray

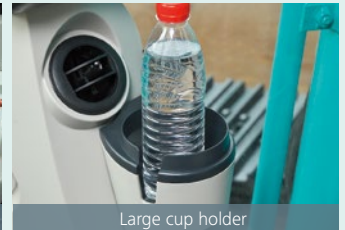

Large cup holder

Safety

ROPS Cab

ROPS (Roll-Over-Protective Structure)-compliant cab clears ISO standards (ISO-12117-2: 2008) and ensures greater safety for the operator should the machine tip over.

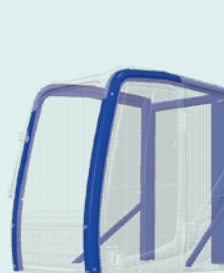

TOP Guard is fitted as standard.

Expanded Field of View for Greater Safety

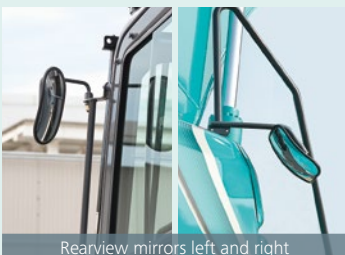

Rearview mirrors left and right

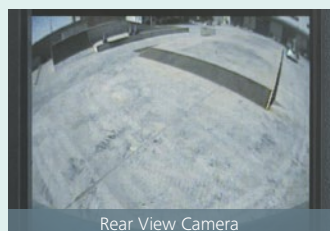

Rear View Camera



Greater safety assured by rearview mirrors on left and right.

A rear view camera is installed as standard to simplify checking for safety behind the machine. The picture appears on the color monitor.

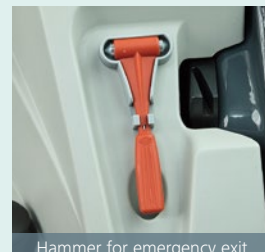

Hammer for emergency exit

GEOSCAN

Excavator Remote Monitoring System

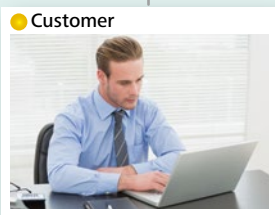

Remote Monitoring for Peace of Mind

GEOSCAN uses satellite communication and internet to relay data, and therefore can be deployed in areas where other forms of communication are difficult.

When a hydraulic excavator is fitted with this system, data on the machine's operation, such as operating hours, location, fuel consumption, and maintenance status can be obtained remotely.

Direct Access to Operational Status

Location Data

• Accurate location data can be obtained even from sites where communications are difficult.

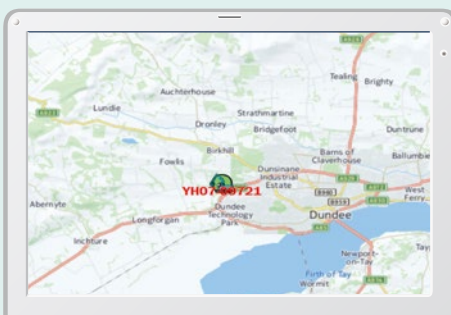

Latest location

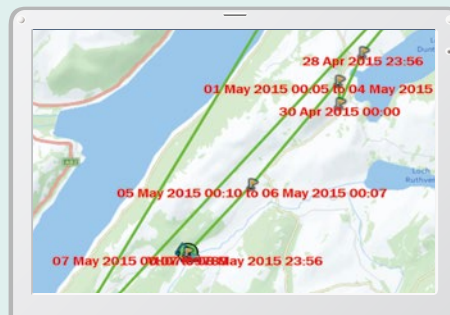

Location records

Period: 11 Apr, 2015 to 10 May, 2015 Search		
Type of Operation	Working Hrs	Ratio
Total Working Hrs	169 Hrs	100 %
Digging Hrs	72.2 Hrs	43 %
Traveling Hrs	18.3 Hrs	11 %
Idle Hrs	15.9 Hrs	9 %
Opt Att Hrs	62.5 Hrs	37 %
Crane Mode Hrs	0 Hrs	0 %

Work data

Operating Hours

- A comparison of operating times of machines at multiple locations shows which locations are busier and more profitable.
- Operating hours on site can be accurately recorded, for running time calculations needed for rental machines, etc.

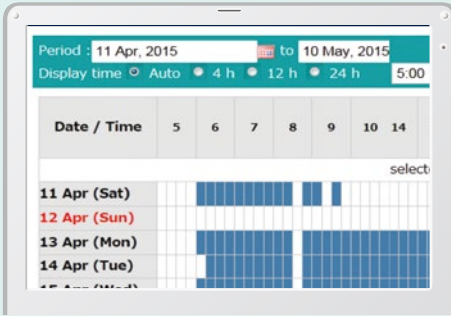

Daily report

Fuel Consumption Data

- Data on fuel consumption and idling times can be used to indicate improvements in fuel consumption.

Work mode	Working Hrs	Total Fuel Consumption
H mode	2:06	24.5 L
S mode	0:00	0.0 L
E mode	169:19	1489.7 L
TOTAL	171:25	1514.2 L

Fuel consumption

Graph of Work Content

- The graph shows how working hours are divided among different operating categories, including digging, idling, traveling and optional operations.

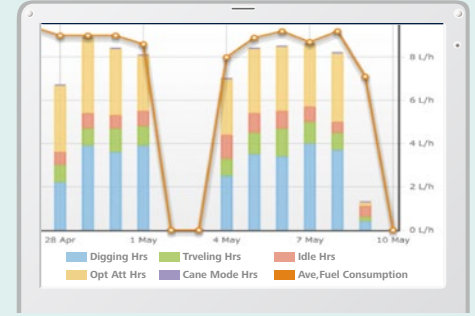

Work status

Maintenance Data and Warning Alerts

Machine Maintenance Data

- Provides maintenance status of separate machines operating at multiple sites.
- Maintenance data is also relayed to KOBELCO service personnel, for more efficient planning of periodic servicing.

Model	Serial No.	Hour Meter	Engine Oil
SK135SRLC-3/SK140SRL	YH07-09721	0.38/0.35	734 Hr
SK135SRLC-3/SK140SRL	YH07-09789	0.38/0.35	73 Hr
SK210LC-9	YQ13-10454	0.8/0.7	960 Hr
SK210LC-9	YQ13-10481	0.8/0.7	549 Hr
SK75SR-	YT08-30374		

Maintenance

Warning Alerts

- This system warns an alert if an anomaly is sensed, preventing damage that could result in machine downtime.

Alarm Information Can Be Received through E-mail

- Alarm information or maintenance notice can be received through E-mail, using a computer or cell phone.

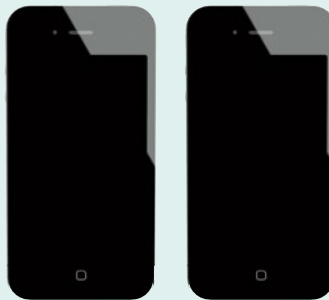

Daily/Monthly Reports

- Operational data downloaded onto a computer helps in formulating daily and monthly reports.

Security System

Engine Start Alarm

- The system can be set an alarm if the machine is operated outside designated time.

Setting Condition Change
 Start time 20 : 00
 Release time 07 : 00

No Working Whole Day
 Mon Tue Wed Thu Fri Sat Sun

Clear

Engine start alarm outside prescribed work time

Area Alarm

- It can be set an alarm if the machine is moved out of its designated area to another location.

Setting Condition
 Around the current (latest) location 1 Km
 Input Latitude and Longitude

Latitude1
 Longitude1
 Latitude2
 Longitude2

Map Clear

Release

Alarm for outside of reset area



Easy, On-the-Spot Maintenance NEW

There is ample space in the engine compartment for a mechanic to do maintenance work inside. The distance between steps is lower so entry and exit is easier. And the mechanic can work in comfort, without contortions or unnatural body positions. Finally, the hood is lighter and easier to raise and lower.



Generous space for maintenance work



Step/Hand rail



Double-element air cleaner

Maintenance Work, Daily Checks, Etc., Can Be Done from Ground Level

The layout allows for easy access from the ground for many daily checks and regular maintenance tasks.

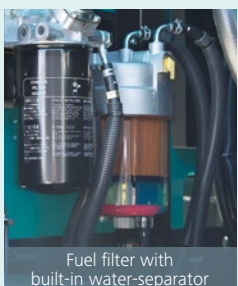

Fuel filter with built-in water-separator

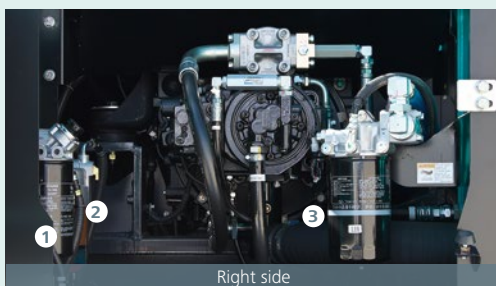

Right side

- ① Fuel filter
- ② Fuel filter with built-in water-separator
- ③ Engine oil filter



Engine oil filter

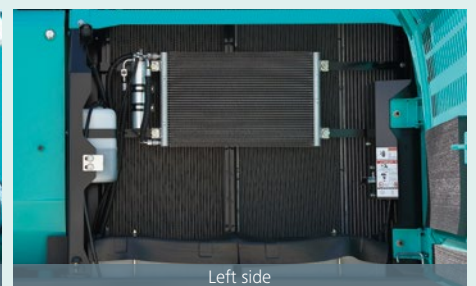

Left side

Laid out for easy access to radiator and cooling system elements

Efficient Maintenance Keeps the Machine in Peak Operating Condition.



MAINTENANCE			
		⌚ 6.7h	
	INTERVAL	REMAINING TIME	EXCHANGE DAY
ENGINE OIL	500 Hr	495 Hr	--/--/--
FUEL FILTER	500 Hr	495 Hr	--/--/--
HYD. FILTER	1000 Hr	995 Hr	--/--/--
HYD. OIL	5000 Hr	4995 Hr	--/--/--

Machine Information Display Function

Examples of displaying maintenance information

- Displays only the maintenance information that's needed, when it's needed
- Self-diagnostic function provides early-warning detection and display of electrical system malfunctions
- Service-diagnostic function makes it easier to check the status of the machine
- Record function of previous breakdowns including irregular and transient malfunction

More Efficient Maintenance Inside the Cab



Easy-access fuse box

More finely differentiated fuses make it easier to locate malfunctions.



Air conditioner filters

Internal and external air conditioner filters can be easily removed without tools for cleaning.

Easy Cleaning

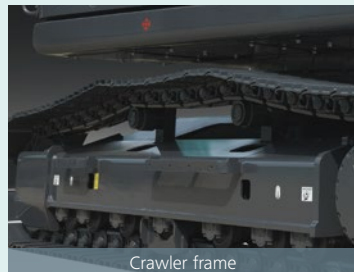

Crawler frame

Special crawler frame design is easily cleaned of mud.



Detachable two-piece floor mat

Detachable two-piece floor mat with handles for easy removal. A floor drain is located under floor mat.

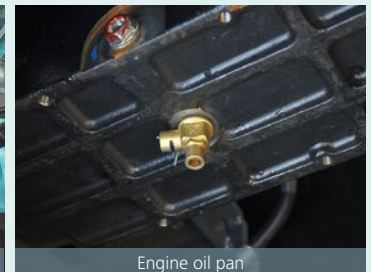

Engine oil pan

Engine oil pan equipped with drain valve.

Long-life hydraulic oil:
5,000
hours

Long-Interval Maintenance

Long-life hydraulic oil reduces cost and labor.

Replacement cycle:
1,000
hours

Highly Durable Super-fine Filter

The high-capacity hydraulic oil filter incorporates glass fiber with superior cleaning power and durability.





Engine

Model	J08ETM-KSDL
Type	Direct injection, water-cooled, 4-cycle diesel engine with turbocharger, intercooler
No. of cylinders	6
Bore and stroke	112 mm x 130 mm
Displacement	7.684 L
Rated power output	197 kW/2,100 min ⁻¹ (ISO 9249)
	209 kW/2,100 min ⁻¹ (ISO 14396)
Max. torque	969 N·m/1,600 min ⁻¹ (ISO 9249)
	998 N·m/1,600 min ⁻¹ (ISO 14396)



Hydraulic System

Pump	
Type	Two variable displacement pumps + One gear pump
Max. discharge flow	2 x 294 L/min, 1 x 21 L/min Extra gear pump 1 x 43 L/min
Relief valve setting	
Boom, arm and bucket	34.3 MPa {350 kgf/cm ² }
Power Boost	37.8 MPa {385 kgf/cm ² }
Travel circuit	34.3 MPa {350 kgf/cm ² }
Swing circuit	29.0 MPa {296 kgf/cm ² }
Control circuit	5.0 MPa {50 kgf/cm ² }
Pilot control pump	Gear type
Main control valve	8-spool
Oil cooler	Air cooled type



Swing System

Swing motor	Axial-piston motor
Brake	Hydraulic; locking automatically when the swing control lever is in neutral position
Parking brake	Oil disc brake, hydraulic operated automatically
Swing speed	10 min ⁻¹ {rpm}
Tail swing radius	3,600 mm
Min. front swing radius	4,310 mm



Attachments

Backhoe bucket and combination

Use	Backhoe bucket			
	Normal digging			
Bucket capacity	Heaped (ISO7451)	m ³	1.20	1.60
	Struck (ISO7451)	m ³	0.84	1.20
Opening width	With side cutter	mm	1,240	1,570
	Without side cutter	mm	1,110	1,450
No. of teeth			4	5
Bucket weight		kg	930	1,140
Combination	2.60 m short arm		○	◎
	3.30 m standard arm		○	◎
	4.15 m long arm		○	△

◎ Standard ○ Recommend △ Loading only × Not recommended



Travel System

Travel motors	2 x axial-piston, two-step motors
Travel brakes	Hydraulic brake per motor
Parking brakes	Oil disc brake per motor
Travel shoes	45 (48) each side
Travel speed	5.8/3.6 km/h
Drawbar pulling force	333 kN (ISO 7464)
Gradeability	70% {35°}

() show SK350LC



Cab & Control

Cab	
All-weather, sound-suppressed steel cab mounted on the high suspension mounts filled with silicone oil and equipped with a heavy, insulated floor mat.	
Control	
Two hand levers and two foot pedals for travel	
Two hand levers for excavating and swing	
Electric rotary-type engine throttle	



Boom, Arm & Bucket

Boom cylinders	140 mm x 1,550 mm
Arm cylinder	170 mm x 1,788 mm
Bucket cylinder	150 mm x 1,193 mm



Refilling Capacities & Lubrications

Fuel tank	503 L
Cooling system	35 L
Engine oil	28.5 L
Travel reduction gear	2 x 8.0 L
Swing reduction gear	7.4 L
Hydraulic oil tank	245 L tank oil level
	410 L hydraulic system



Working Ranges

Unit: m

Boom	Arm	6.50 m		
		Short 2.6 m	Standard 3.3 m	Long 4.15 m
Range				
a- Max. digging reach		10.61	11.26	11.97
b- Max. digging reach at ground level		10.4	11.06	11.79
c- Max. digging depth		6.86	7.56	8.41
d- Max. digging height		10.26	10.58	10.7
e- Max. dumping clearance		7.06	7.37	7.53
f- Min. dumping clearance		3.32	2.62	1.77
g- Max. vertical wall digging depth		5.84	6.61	7.15
h- Min. swing radius		4.45	4.31	4.43
i- Horizontal digging stroke at ground level		4.21	5.82	7.21
j- Digging depth for 2.4 m (8') flat bottom		6.67	7.4	8.27
Bucket capacity ISO heaped m ³		1.6	1.4	1.2

Digging Force (ISO 6015)

Unit: kN (tf)

Arm length	Short 2.6 m	Standard 3.3 m	Long 4.15 m
Bucket digging force	221 244*	222 244*	221 243*
Arm crowding force	205 225*	163 180*	140 154*

*Power Boost engaged.

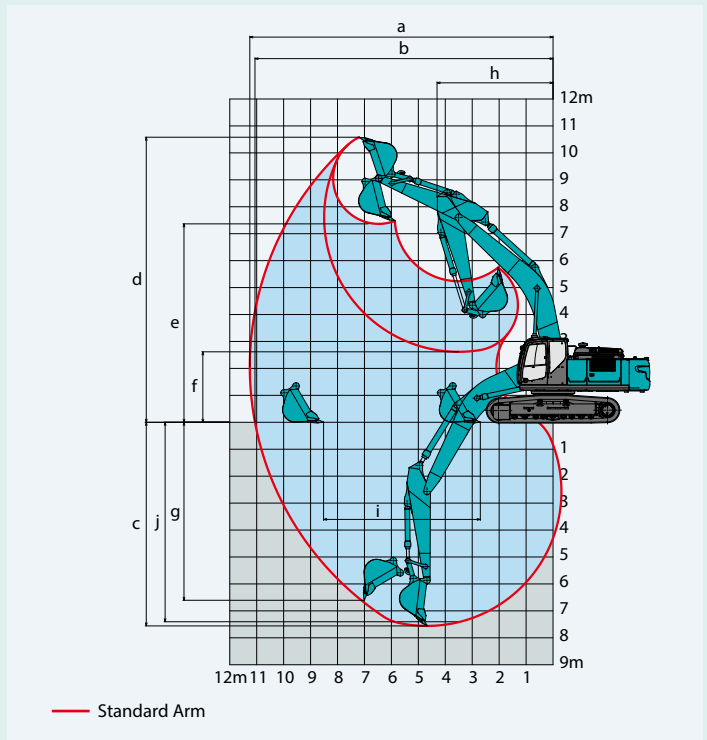

Dimensions

Arm length	Short 2.6 m	Standard 3.3 m	Long 4.15 m
A Overall length	11,380	11,300	11,330
B Overall height (to top of boom)	3,680	3,420	3,590
C Overall width of crawler	3,190		
D Overall height (to top of cab)	3,200		
E Ground clearance of rear end*	1,190		
F Ground clearance*	500		
G Tail swing radius	3,600		

Unit: mm

G' Distance from center of swing to rear end		3,600
H Tumbler distance	SK330	3,720
	SK350LC	4,050
I Overall length of crawler	SK330	4,630
	SK350LC	4,960
J Track gauge		2,590
K Shoe width		600
L Overall width of upperstructure		2,980

*Without including height of shoe

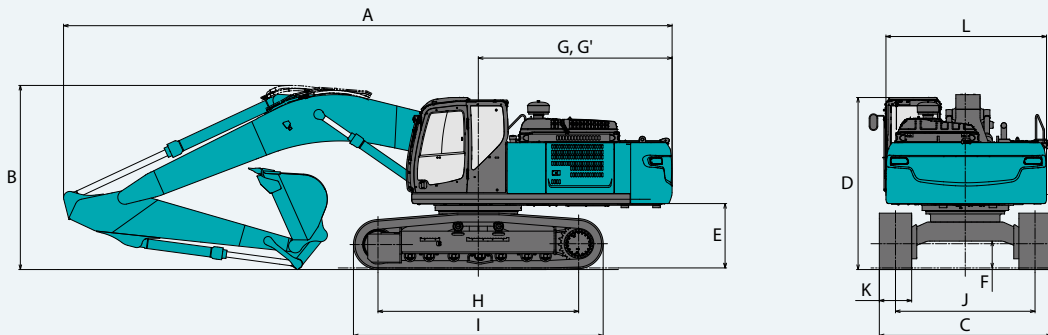

Operating Weight & Ground Pressure

In standard trim, with standard boom, 3.3 m arm, and 1.4 m³ ISO heaped bucket

Shaped		Triple grouser shoes (even height)		
Shoe width	mm	600	700	800
Overall width of crawler	SK330 mm	3,190	3,290	3,390
	SK350LC mm	3,190	3,290	3,390
Ground pressure	SK330 kPa (kgf/cm ²)	71	63	56
	SK350LC kPa (kgf/cm ²)	67	59	52
Operating weight	SK330 kg	35,200	36,300	36,700
	SK350LC kg	35,900	36,800	37,200

Lift Capacities

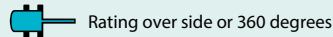
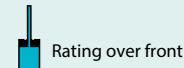
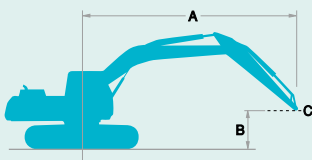

A: Reach from swing centerline to arm top
 B: Arm top height above/below ground
 C: Lift point
 Bucket: Without bucket
 Relief valve setting: 37.8 MPa (385 kgf/cm²)

SK330		Boom: 6.5 m Arm: 3.3 m, Bucket: without Shoe: 600 mm (Heavy Lift)															
B	A	1.5 m		3.0 m		4.5 m		6.0 m		7.5 m		9.0 m		At Max. Reach		Radius	
9.0 m	kg														*6,370	*6,370	6.56 m
7.5 m	kg									*7,800	7,800				*5,840	*5,840	7.86 m
6.0 m	kg									*7,920	7,700				*5,650	*5,650	8.71 m
4.5 m	kg							*9,710	*9,710	*8,480	7,420	7,650	5,530		*5,650	5,260	9.25 m
3.0 m	kg					*15,070	14,790	*11,140	9,790	*9,220	7,080	7,480	5,370		*5,840	4,900	9.52 m
1.5 m	kg					*17,270	13,700	*12,400	9,200	9,550	6,760	7,310	5,210		*6,210	4,770	9.54 m
G.L.	kg					*18,030	13,210	12,860	8,830	9,300	6,520	7,180	5,090		6,830	4,850	9.33 m
-1.5 m	kg			*15,400	*15,400	*17,660	13,110	12,690	8,670	9,180	6,410				7,320	5,180	8.85 m
-3.0 m	kg	*17,520	*17,520	*22,230	*22,230	*16,350	13,240	*12,470	8,700	9,230	6,460				8,370	5,910	8.07 m
-4.5 m	kg			*18,150	*18,150	*13,770	13,600	*10,460	8,960						*8,520	7,500	6.88 m

SK330		Boom: 6.5 m Arm: 4.15 m, Bucket: without Shoe: 600 mm (Heavy Lift)															
B	A	1.5 m		3.0 m		4.5 m		6.0 m		7.5 m		9.0 m		At Max. Reach		Radius	
9.0 m	kg									*5,080	*5,080				*4,780	*4,780	7.56 m
7.5 m	kg														*4,470	*4,470	8.71 m
6.0 m	kg									*6,880	*6,880	*6,590	5,680		*4,360	*4,360	9.49 m
4.5 m	kg									*7,510	7,490	*6,980	5,530		*4,380	*4,380	9.98 m
3.0 m	kg			*21,130	*21,130	*13,030	*13,030	*9,930	*9,930	*8,340	7,090	*7,410	5,320		*4,530	4,270	10.23 m
1.5 m	kg					*15,740	13,920	*11,400	9,230	*9,180	6,690	7,210	5,100		*4,820	4,140	10.25 m
G.L.	kg			*10,830	*10,830	*17,260	13,080	*12,450	8,700	9,160	6,380	7,020	4,910		*5,290	4,180	10.05 m
-1.5 m	kg	*10,180	*10,180	*14,960	*14,960	*17,590	12,750	12,440	8,420	8,950	6,180	6,910	4,810		*6,050	4,400	9.62 m
-3.0 m	kg	*14,870	*14,870	*20,400	*20,400	*16,920	12,740	12,360	8,340	8,900	6,130				7,030	4,900	8.91 m
-4.5 m	kg	*20,320	*20,320	*21,120	*21,120	*15,150	12,980	*11,460	8,480	*8,700	6,270				*8,050	5,930	7.85 m
-6.0 m	kg			*15,750	*15,750	*11,680	*11,680	*8,490	*8,490						*7,890	*7,890	6.26 m

SK330		Boom: 6.5 m Arm: 2.6 m, Bucket: without Shoe: 600 mm (Heavy Lift)										At Max. Reach		Radius	
B	A	3.0 m		4.5 m		6.0 m		7.5 m							
7.5 m	kg												*8,750	8,330	7.06 m
6.0 m	kg												*8,530	6,660	8.00 m
4.5 m	kg			*13,440	*13,440	*10,450	10,120	*9,010	7,220				8,090	5,810	8.58 m
3.0 m	kg					*11,750	9,460	*9,630	6,900				7,520	5,370	8.87 m
1.5 m	kg					*12,780	8,950	9,400	6,620				7,350	5,220	8.89 m
G.L.	kg			*17,790	13,010	12,690	8,670	9,210	6,440				7,550	5,340	8.66 m
-1.5 m	kg			*16,890	13,070	12,620	8,600	9,170	6,400				8,210	5,780	8.15 m
-3.0 m	kg	*19,120	*19,120	*15,080	13,310	*11,700	8,740						*9,090	6,810	7.29 m
-4.5 m	kg	*14,520	*14,520	*11,710	*11,710								*8,570	*8,570	5.95 m

SK350LC		Boom: 6.5 m Arm: 3.3 m, Bucket: without Shoe: 600 mm (Heavy Lift)															
B	A	1.5 m		3.0 m		4.5 m		6.0 m		7.5 m		9.0 m		At Max. Reach		Radius	
9.0 m	kg														*6,370	*6,370	6.56 m
7.5 m	kg									*7,800	*7,800				*5,840	*5,840	7.86 m
6.0 m	kg									*7,920	7,810				*5,650	*5,650	8.71 m
4.5 m	kg							*9,710	*9,710	*8,480	7,540	*7,840	5,620		*5,650	5,350	9.25 m
3.0 m	kg					*15,070	15,030	*11,140	9,950	*9,220	7,200	*8,140	5,470		*5,840	4,990	9.52 m
1.5 m	kg					*17,270	13,930	*12,400	9,360	*9,920	6,880	8,230	5,300		*6,210	4,860	9.54 m
G.L.	kg					*18,030	13,440	*13,140	8,980	*10,380	6,640	8,100	5,180		*6,840	4,940	9.33 m
-1.5 m	kg			*15,400	*15,400	*17,660	13,340	*13,210	8,820	*10,400	6,530				*7,890	5,270	8.85 m
-3.0 m	kg	*17,520	*17,520	*22,230	*22,230	*16,350	13,480	*12,470	8,860	*9,670	6,580				*8,620	6,010	8.07 m
-4.5 m	kg			*18,150	*18,150	*13,770	*13,770	*10,460	9,110						*8,520	7,630	6.88 m

- Notes:**
- Do not attempt to lift or hold any load that is greater than these lift capacities at their specified lift point radius and heights. Weight of all accessories must be deducted from the above lift capacities.
 - Lift capacities are based on machine standing on level, firm, and uniform ground. User must make allowance for job conditions such as soft or uneven ground, out of level conditions, side loads, sudden stopping of loads, hazardous conditions, experience of personnel, etc.
 - Arm top defined as lift point.
 - The above lift capacities are in compliance with ISO 10567. They do not exceed 87% of hydraulic lift capacity or 75% of tipping load. Lift capacities marked with an asterisk (*) are limited by hydraulic capacity rather than tipping load.
 - Operator should be fully acquainted with the Operator's and Maintenance Instructions before operating this machine. Rules for safe operation of equipment should be adhered to at all times.
 - Lift capacities apply to only machine as originally manufactured and normally equipped by KOBELCO CONSTRUCTION MACHINERY CO., LTD.

SK350LC		Boom: 6.5 m Arm: 4.15 m, Bucket: without Shoe: 600 mm (Heavy Lift)														
B \ A		1.5 m		3.0 m		4.5 m		6.0 m		7.5 m		9.0 m		At Max. Reach		Radius
9.0 m	kg									*5,080	*5,080			*4,780	*4,780	7.56 m
7.5 m	kg													*4,470	*4,470	8.71 m
6.0 m	kg									*6,880	*6,880	*6,590	5,770	*4,360	*4,360	9.49 m
4.5 m	kg									*7,510	*7,510	*6,980	5,620	*4,380	*4,380	9.98 m
3.0 m	kg			*21,130	*21,130	*13,030	*13,030	*9,930	*9,930	*8,340	7,210	*7,410	5,410	*4,530	4,350	10.23 m
1.5 m	kg					*15,740	14,150	*11,400	9,380	*9,180	6,810	*7,870	5,190	*4,820	4,220	10.25 m
G.L.	kg			*10,830	*10,830	*17,260	13,310	*12,450	8,860	*9,830	6,490	7,930	5,010	*5,290	4,260	10.05 m
-1.5 m	kg	*10,180	*10,180	*14,960	*14,960	*17,590	12,980	*12,900	8,570	*10,130	6,300	7,820	4,910	*6,050	4,490	9.62 m
-3.0 m	kg	*14,870	*14,870	*20,400	*20,400	*16,920	12,970	*12,650	8,500	*9,890	6,250			*7,350	5,000	8.91 m
-4.5 m	kg	*20,320	*20,320	*21,120	*21,120	*15,150	13,210	*11,460	8,630	*8,700	6,390			*8,050	6,040	7.85 m
-6.0 m	kg			*15,750	*15,750	*11,680	*11,680	*8,490	*8,490					*7,890	*7,890	6.26 m

SK350LC		Boom: 6.5 m Arm: 2.6 m, Bucket: without Shoe: 600 mm (Heavy Lift)										
B \ A		3.0 m		4.5 m		6.0 m		7.5 m		At Max. Reach		Radius
7.5 m	kg									*8,750	8,450	7.06 m
6.0 m	kg					*9,350	*9,350	*8,600	7,580	*8,530	6,770	8.00 m
4.5 m	kg			*13,440	*13,440	*10,450	10,270	*9,010	7,340	*8,500	5,910	8.58 m
3.0 m	kg					*11,750	9,620	*9,630	7,020	8,460	5,470	8.87 m
1.5 m	kg					*12,780	9,110	*10,190	6,740	8,290	5,320	8.89 m
G.L.	kg			*17,790	13,250	*13,210	8,820	10,430	6,560	8,520	5,430	8.66 m
-1.5 m	kg			*16,890	13,300	*12,910	8,760	*10,150	6,520	*9,070	5,890	8.15 m
-3.0 m	kg	*19,120	*19,120	*15,080	13,540	*11,700	8,900			*9,090	6,930	7.29 m
-4.5 m	kg	*14,520	*14,520	*11,710	*11,710					*8,570	*8,570	5.95 m

STANDARD EQUIPMENT

ENGINE

- Engine, HINO J08ETM-KSDL, diesel engine with turbocharger and intercooler
- Automatic engine deceleration
- Auto Idle Stop (AIS)
- Batteries (2 x 12V - 96Ah)
- Starting motor (24V - 5 kW), 60 amp alternator
- Automatic engine shut-down for low engine oil pressure
- Engine oil pan drain cock
- Double element air cleaner

CONTROL

- Working mode selector (H-mode, S-mode and ECO-mode)
- Power Boost

SWING SYSTEM & TRAVEL SYSTEM

- Swing rebound prevention system
- Straight propel system
- Two-speed travel with automatic shift down
- Sealed & lubricated track links
- Grease-type track adjusters
- Automatic swing brake

HYDRAULIC

- Arm regeneration system
- Auto warm up system
- Aluminum hydraulic oil cooler

MIRRORS & LIGHTS

- Two rear view mirrors
- Three front working lights (2 for boom, one for right storage box)

CAB & CONTROL

- Two control levers, pilot-operated
- Horn, electric
- Cab light (interior)
- Luggage tray
- Large cup holder
- Detachable two-piece floor mat
- Headrest
- Handrails
- Intermittent windshield wiper with double-spray washer
- Skylight
- Tinted safety glass
- Pull-up type front window and removable lower front window
- Easy-to-read multi-display color monitor
- Automatic air conditioner
- Emergency escape hammer
- Suspension seat
- Radio (AUX & Bluetooth*)
- TOP guard
- Boom & Arm safety valve
- GEOSCAN
- Travel alarm
- Quick hitch piping

OPTIONAL EQUIPMENT

- Various optional arms
- Wide range of shoes
- Additional track guide
- Multi control valve
- Extra hydraulic circuit
- Two cab lights
- Air suspension seat
- Rain visor (may interfere with bucket action)
- Cab guard
- Refueling pump

Note: Standard and optional equipment may vary. Consult your KOBELCO dealer for specifics. Bluetooth® is a registered trademark of the Bluetooth SIG Inc.

Note: This catalog may contain attachments and optional equipment that are not available in your area. And it may contain photographs of machines with specifications that differ from those of machines sold in your areas. Please consult your nearest KOBELCO distributor for those items you require. Due to our policy of continuous product improvements all designs and specifications are subject to change without advance notice. Copyright by **KOBELCO CONSTRUCTION MACHINERY CO., LTD.** No part of this catalog may be reproduced in any manner without notice.

KOBELCO CONSTRUCTION MACHINERY CO., LTD.

5-15, Kitashinagawa 5-chome, Shinagawa-ku, Tokyo 141-8626 JAPAN
Tel: +81 (0) 3-5789-2146 Fax: +81 (0) 3-5789-2135
www.kobelcocm-global.com

Inquiries To: