

# KOBELCO

SK225SR/SK230SR LC-5

## SK225SR SK230SR<sub>LC</sub>



**We Save You Fuel**  
Achieving a Low-Carbon Society

# Power Meets Efficiency

With iNDR for even quieter operation.



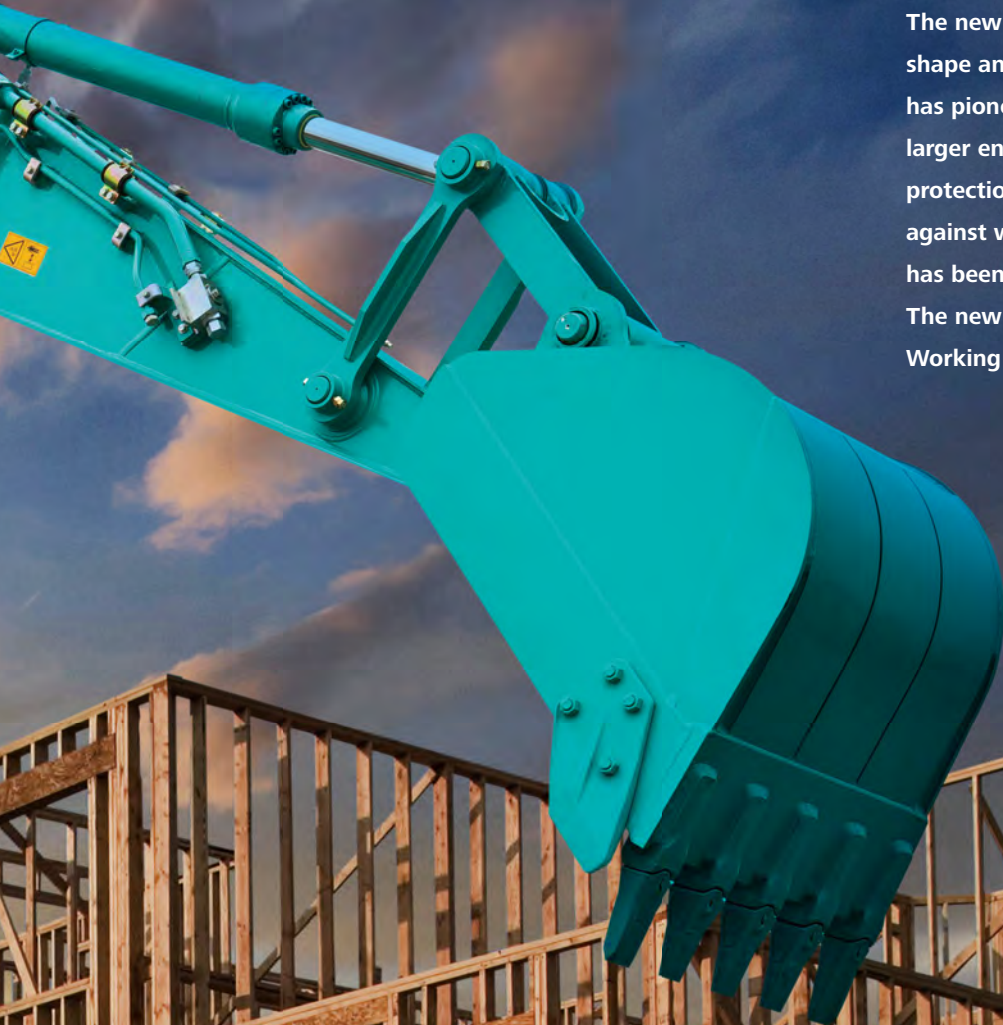

“KOBELCO has made the short rear swing excavator the standard for mid-sized machines. And with ongoing development in innovations such as the iNDr noise reduction system that both shuts out dust and cuts noise, KOBELCO is boosting value and leading the industry with construction machinery ideally suited to the urban environment.

The new SK225SR SK230SR<sub>LC</sub> retains the compact shape and iNDr system advantages that KOBELCO has pioneered, but it has been fitted with a new and larger engine assembly for improved environmental protection. Low fuel consumption is balanced against work performance, and machine durability has been advanced.

The new worldwide-model SK225SR SK230SR<sub>LC</sub>. Working for the planet.”



**SK225SR SK230SR<sub>LC</sub>**

# Low Noise and Easy Maintenance Mean Greater A New Design Approach Leads to a Revolutionary

By reviewing the iNDr configuration, Kobelco achieved both great visibility and a compelling design even though the engine compartment has been enlarged to meet Stage V standards, maintaining the value of iNDr.

iNDr absorbs sound energy to minimize noise by making a path of air, which cools down engine, as one engine cooling ducts. The new model is equipped with a selective catalytic reduction (SCR) unit, which required a new design with two offset ducts on top. This allows ample space to absorb engine noise, making these new excavators as quiet as conventional models.

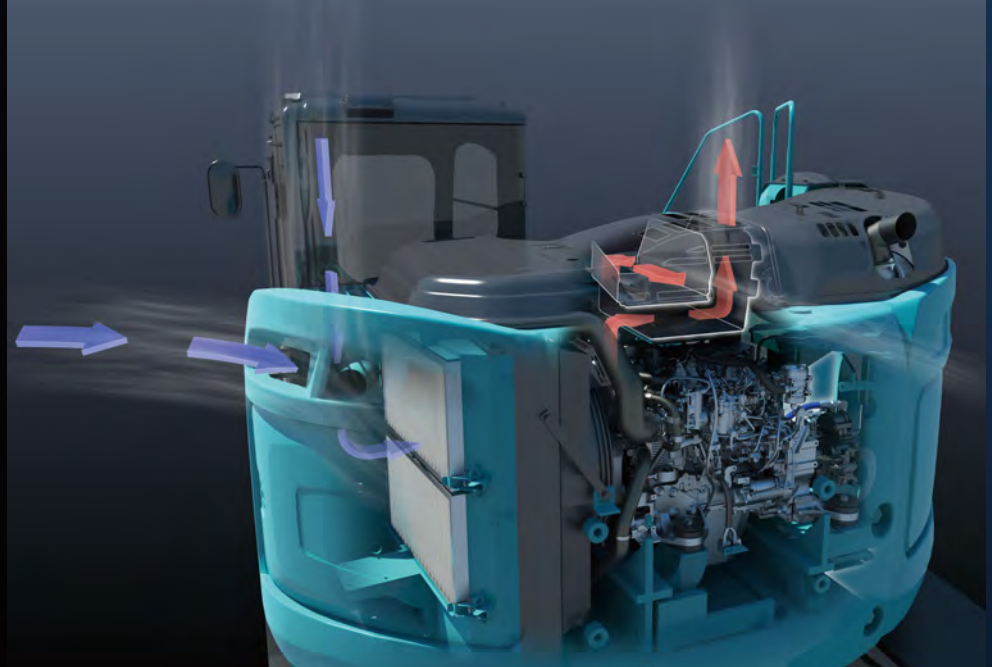

## The Results Are Exceptional. The Big Merits:

### “Ultimate Low Noise” is achieved by minimizing sound leakage during operation

Kobelco’s “Ultimate Low Noise” system exceeds all noise standards. Noise from the engine and cooling fan is absorbed by the duct, reducing machine’s noise signature to the lowest in the industry. Perfect for urban utility renewal projects.

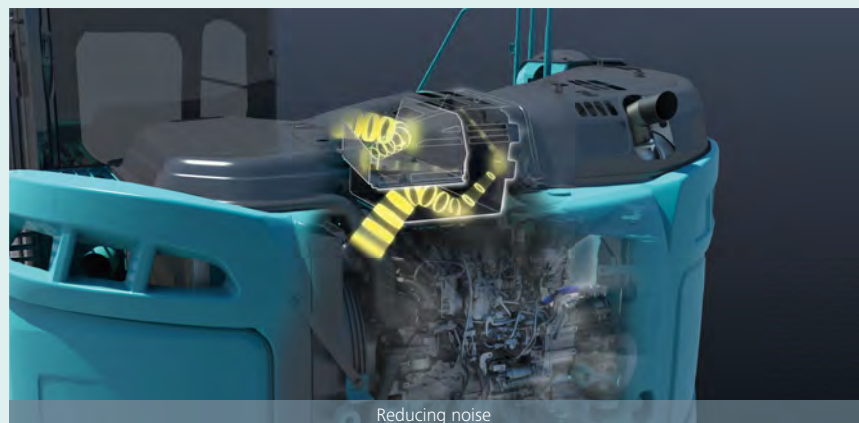

### Eliminating dust maintains cooling system performance

The high-density 60-mesh filter\* blocks out dust in the intake air. This prevents clogging of the cooling system and the air cleaner, which maintains peak performance. The waveform filter allows air through the tops of the waves while collecting dust at the bottom, ensuring a smooth airflow.

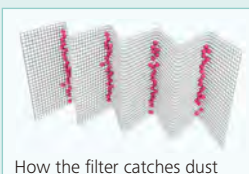

\* “60-mesh” means that there are 60 holes formed by horizontal and vertical wires in every square inch of filter.



### Easy filter maintenance system simplifies cleaning

Daily inspection consists of a visual check of the iNDr filter only. If it looks dirty, it can be removed and washed without special tools.

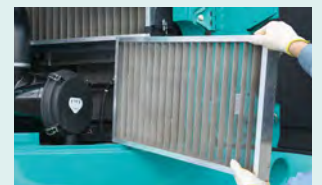

# Value Than Ever Double Offset Duct Structure



## Wide, clear view to the rear

Even with the larger engine compartment, the design minimizes hood height, ensuring an excellent direct view to the rear. In addition, the operator can monitor conditions behind the machine with clear, wide-angle images from the rear-view camera, which comes as standard equipment.



**NOx emissions cut:**

## New, Environmentally Friendly Engine

### SCR System with Urea

**NEW**

The engine exhaust system has an SCR system that converts NOx emissions into harmless nitrogen and water. Combining this with a post-exhaust gas treatment system that captures and disposes of PM, the SK225SR/SK230SRLC has a much cleaner exhaust that meets Stage V exhaust emission standards.



**NOx reduction rate**  
(Compared to previous models)

About **88%** decrease

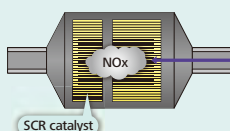

## Reduces fuel consumption and minimizes exhaust emissions

Hino engines are renowned for fuel efficiency and environmental performance, and KOBELCO has tuned them specifically for construction machinery. The high-pressure common rail fuel injection system, the variable-geometry (VG) turbocharger, and the exhaust gas recirculation (EGR) system reduce particulate matter (PM) while the large EGR cooler greatly reduces the formation of Nitrogen Oxide (NOx) gases.



At high temperatures, nitrogen and oxygen combine to produce nitrogen oxides (NOx). Reducing the amount of oxygen and lowering the combustion temperature results in much less NOx.

### EGR cooler

While ensuring sufficient oxygen for combustion, cooled emission gases are mixed with the intake air and recirculated into the engine. This reduces oxygen content and lowers combustion temperature.

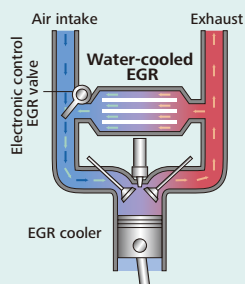

**PM emissions cut:**

Particulate matter (PM) is mostly soot resulting from incomplete combustion; Improved combustion efficiency reduces PM emissions. filter further reduces PM emissions.

### Common rail system

High-pressure injection atomizes the fuel, and more precise injection improves combustion efficiency. This also contributes to better fuel economy.

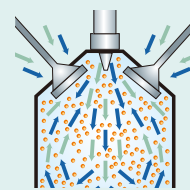

Common rail system

# Unbeatable Cost Performance

**Greater Work Capacity:  
Exceeding Expectations in Productivity**

## Improved Fuel Efficiency Contributes to High Performance

### Superior Digging Volume

This excavator offers dynamic digging force even as it minimizes fuel consumption rates, achieving class-leading work volume. H-mode with an increased torque setting delivers about 8% greater digging volume.

■ Digging volume/hour  
(Compared to H-mode on previous models)



■ Max. bucket digging force (Power Boost engaged)

**132kN (ISO 6015)**

■ Max. arm crowding force (Power Boost engaged)

**96.8kN (ISO 6015)**



## In Pursuit of Improved Fuel Efficiency

### Operation Mode

Fuel consumption is lower in H-mode/S-mode/ECO-mode in comparison with the previous model.

■ Compared to previous models

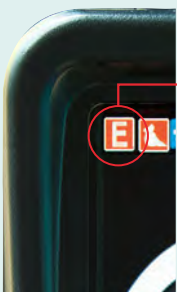

**S** S-mode  
..... About **5%**  
improvement

**E** ECO-mode  
..... About **18%**  
improvement

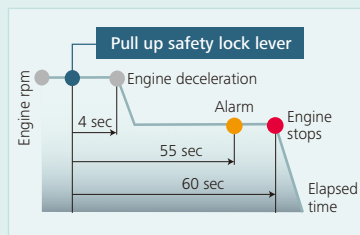

### AIS (Auto Idle Stop)

If the boarding/disembarking lever is left up, the engine will stop automatically. This eliminates wasteful idling during standby, saving fuel and reducing CO<sub>2</sub> emissions as well.

### Hydraulic system engineered to reduce energy loss

Kobelco's proprietary hydraulic systems offer hydraulic line positioning that reduces friction resistance and valves designed for higher efficiency, minimizing energy loss throughout the system.

**Always and forever.  
Yesterday, today, and tomorrow.  
We're obsessed with fuel efficiency**

Over the past 8 years, KOBELCO has achieved an average fuel consumption reduction of 31% across its fleet. We vow to lead the industry in improving fuel efficiency.

■ Compared to SK200SR-IS (2004)

**E** ECO-mode (SK230SRLC-5) • • • About **31%** improvement

**Ideal for Urban Work Sites Provides a Broad Working Range, Even in Close Quarters**

**Minimal swing radius improves efficiency**

The tail of the upper body extends very little past the crawlers, so the operator can concentrate on the job at hand. This also reduces the risk of collision damage.

**Easy access for combined space**

2,800mm overall width of crawler for SK225SR allows easy access to combined space.

**Easy workability in less than 4,050mm of space**

The compact design allows continuous 180° dig, swing, and load operations within a working space of just 4.06m.

**Seamless feeling, smooth combined operations**

The machines have inherited the various systems that make inching and combined operations easy and accurate. Leveling and other combined operations can be carried out with graceful ease.

**Swing operation cuts cycle times: 12.6min<sup>-1</sup>**

Fast cycle times as a result of fast swing and boom operations.

**Strong drawbar pulling force produces powerful travel capabilities**

These new excavators handle steep slopes and rough roads with ease while ensuring smooth changes in direction.

**Drawbar pulling force: 229kN**

**Excellent working ranges**

Greater working ranges with class-topping vertical digging depth.

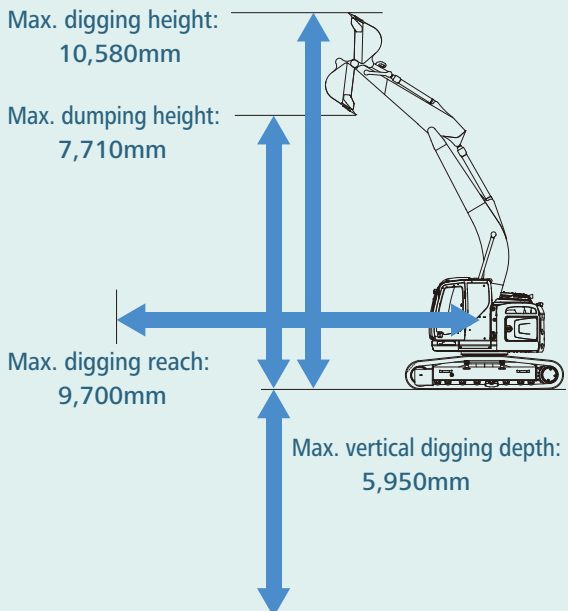

**Easy hydraulic piping for quick hitch**

A quick hitch hydraulic line, which speeds up attachment changes, is available as standard.



# Comprehensive Safety and Intuitive Operation

User-friendly design and enhanced safety means greater efficiency and productivity.



Operator-friendly Features Include Controls that Are Easy to See, Easy to Use



## Multi-Display in color

Brilliant colors and graphic displays are easy to recognize on the LCD multi-display in the console. The display shows fuel consumption, maintenance intervals, and more.

- 1 Analog gauge provides an intuitive reading of fuel level and engine water temperature
- 2 Green indicator light shows low fuel consumption during operation
- 3 PM accumulation display (left)/Urea level gauge (right)
- 4 Fuel consumption
- 5 Digging mode switch
- 6 Monitor display switch

## One-touch attachment mode switch

A simple flick of a switch converts the hydraulic circuit and flow amount to match attachment changes. Icons help the operator to confirm the proper configuration at a glance.



## Safety

### ROPS cab

ROPS (Roll-Over-Protective Structure)-compliant cab clears ISO standards (ISO-12117-2: 2008) and ensures greater safety for the operator should the machine tip over.



Top Guard level II  
(Meets ISO10262)



Mounting brackets for vandalism guards are standard equipment (contact your KOBELCO dealer to fit vandalism).

### Expanded field of view for greater safety



Left and right rear-view mirrors/Right bottom clearance mirror



Rear view from cab

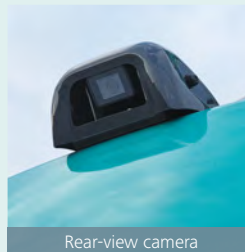

Rear-view camera

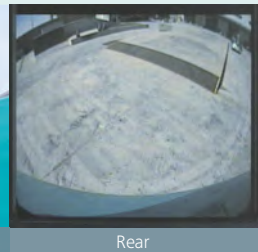

Rear

### Option right side camera **NEW**

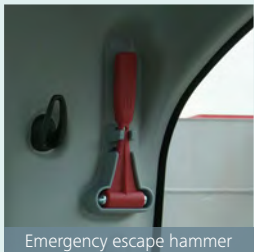

Emergency escape hammer



Right-side camera



Monitor Rear

Right



PM accumulation display (left)/  
Urea level gauge (right)



Fuel consumption

	INTERVAL	REMAINING TIME	EXCHANGE DAY
ENGINE OIL	500	494	---/---
FUEL FILTER	500	494	---/---
HYD. FILTER	1000	994	---/---
HYD. OIL	5000	4994	---/---

Maintenance



Breaker mode



Nibbler mode

# Cab Design That Puts the Operator First

Wide and open, the cab's interior overflows with features that streamline operation



## Comfort

### Big roomy cab

The cube design makes the most of straight lines, so the cab interior is 4% more spacious than before. Operating space literally spreads out before the operator. And the 50Pa airtightness keeps dust outside.

### A Light Touch on the Lever Means Smoother, Less Tiring Work NEW

It takes 38% less effort to work the operation lever, which reduces fatigue over long working hours or continued operations.



### Wide-open field of view

On the right side, the large single window has no center pillar, and the whole cab is designed for a wide field of view, giving the operator a direct view ahead and to the left and right. Mirror makes it easy for the operator to make sure things are safe all around.



## Wide doors and ample head clearance mean smooth entry and exit

The control box and safety lock lever tilt up at a larger angle, and the door handle height is positioned for easy cab entry and exit.



## More comfortable seat means higher productivity

The cab interior offers a host of operator comforts. The seat guarantees comfort whether on the job or at rest, and everything is ergonomically planned and laid out for smooth, stress-free operation.



Seat suspension absorbs vibration

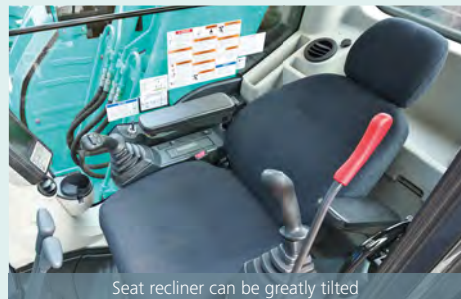

Seat recliner can be greatly tilted



Double slides allow adjustment for optimum comfort

## Equipment designed for comfort and convenience



### Bluetooth installed **NEW** radio

Bluetooth installed to allow connections with audio devices.



### Powerful automatic air conditioner

Also standard is an automatic air conditioner that maintains a comfortable interior environment all year around.



Spacious storage tray

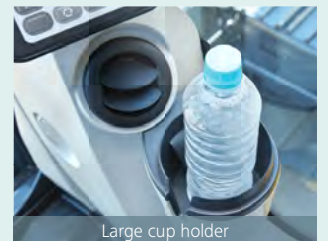

Large cup holder



USB/AUX



12V power outlet

# Proper Maintenance Ensures Peak Efficiency

Kobelco machines are designed for quick, simple inspection and maintenance.



## Machine Information Display Function

- Displays only the maintenance information that's needed, when it's needed
- Self-diagnostic function provides early-warning detection and display of electrical system malfunctions
- Service-diagnostic function makes it easier to check the status of the machine
- Record function of previous breakdowns including irregular and transient malfunction

Maintenance information display

## Easy, on-the-spot maintenance NEW



### Urea tank

Urea filler cap is placed on the step for easy access.



### Engine maintenance

Setting up maintenance area one step down allows easy access to the engine.



### Handrail

The handrail on the step side allows easy access to the maintenance port on the upper arm.

## Maintenance work, daily checks, etc. can be done from ground level

The layout allows for easy access from the ground for many daily checks and regular maintenance tasks.



Engine oil filter



Fuel filter with built-in water-separator



iNDR filter/radiator reservoir tank/air cleaner



Control valve

## Fast maintenance requires only a few procedures



Washer fluid tank is located under the cab floor mat.



Engine oil quick-drain valve can be turned without special tool.



Fuel tank features bottom flange and large drain valve.

# Quality That Keeps on Shining. Valuable Assets Take Your Business to the Next Level

Structural strength and proven reliability mean these machines can deal with heavy work loads and perform in rigorous site environments. From the lifecycle viewpoint, these machines maintain their value throughout their service lives.



## Improved Filtration System Reliability

Clean, contaminant-free fuel and hydraulic fluid are essential to stable performance. The improved filtration systems reduce the risk of mechanical trouble and enhance longevity and durability.

### Hydraulic fluid filter **NEW**

Recognized as the best in the industry, our premium-fine filter separates out even the smallest particles. New cover prevents contamination when changing filters.



### Hydraulic fluid filter clog detector **NEW**

Pressure sensors at the inlet and outlet of the hydraulic fluid filter monitor differences in pressure to determine the degree of clogging. If the difference in pressure exceeds a predetermined level, a warning appears on the multi-display, so any contamination can be removed from the filter before it reaches the hydraulic fluid reservoir.

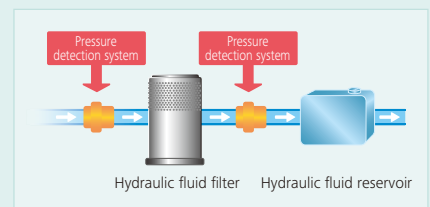

### Enlarged fuel filter **NEW**

The enlarged fuel filter with built-in water separator maximizes filtering performance.

Long-life hydraulic oil:  
**5,000**  
hours

### Long-interval maintenance

Long-life hydraulic oil reduces cost and labor.

Replacement cycle:  
**1,000**  
hours

### Highly durable premium-fine filter

The high-capacity hydraulic oil filter incorporates glass fiber with superior cleaning power and durability.



### Double-element air cleaner

The large-capacity element features a double-filter structure that keeps the engine running clean even in industrial environments.

### Easy cleaning saves time



Detachable two-piece floor mat has handles for easy removal. The mat's raised edges trap dirt and grit for easy cleaning.



Special crawler frame design makes it easy to clean off mud.



# GEOSCAN

## Excavator Remote Monitoring System

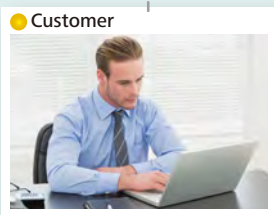

### Remote monitoring for peace of mind

KOMEXS (Kobelco Monitoring Excavator System) uses satellite communication and internet to relay data, and therefore can be deployed in areas where other forms of communication are difficult.

When a hydraulic excavator is fitted with this system, data on the machine's operation, such as operating hours, location, fuel consumption, and maintenance status can be obtained remotely.

### Direct Access to Operational Status

#### Location data

• Accurate location data can be obtained even from sites where communications are difficult.

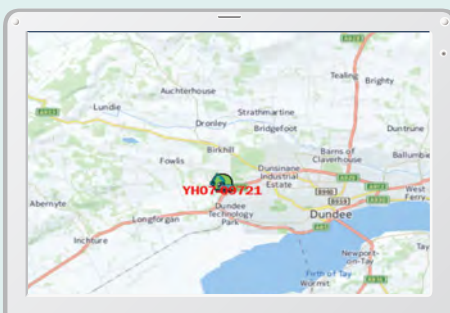

Latest location

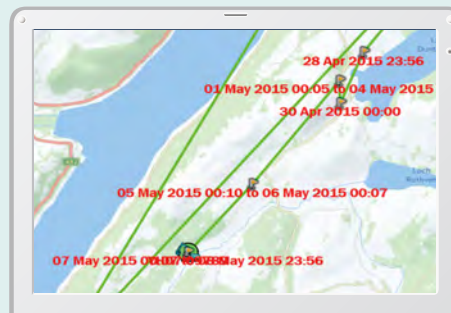

Location records

Type of Operation	Working Hrs	Ratio
Total Working Hrs	169 Hrs	100 %
Digging Hrs	72.2 Hrs	43 %
Traveling Hrs	18.3 Hrs	11 %
Idle Hrs	15.9 Hrs	9 %
Opt Att Hrs	62.5 Hrs	37 %
Crane Mode Hrs	0 Hrs	0 %

Work data

## Operating hours

- A comparison of operating times of machines at multiple locations shows which locations are busier and more profitable.
- Operating hours on site can be accurately recorded, for running time calculations needed for rental machines, etc.

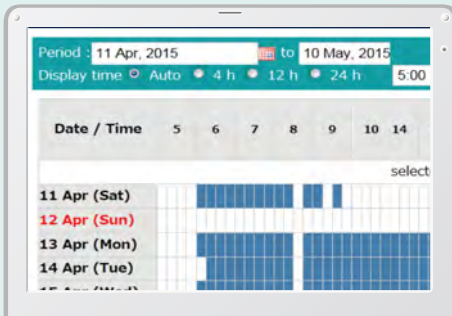

Daily report

## Fuel consumption data

- Data on fuel consumption and idling times can be used to indicate improvements in fuel consumption.

Work mode	Working Hrs	Total Fuel Consumption
H mode	2:06	24.5 L
S mode	0:00	0.0 L
E mode	169:19	1489.7 L
<b>TOTAL</b>	<b>171:25</b>	<b>1514.2 L</b>

Fuel consumption

## Graph of work content

- The graph shows how working hours are divided among different operating categories, including digging, idling, traveling and optional operations.

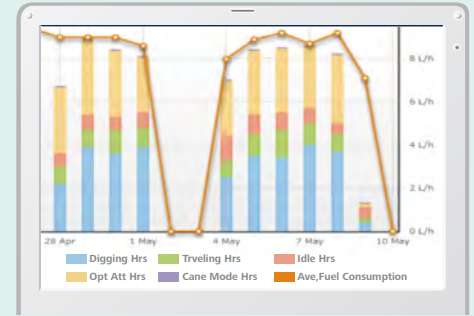

Work status

## Maintenance Data and Warning Alerts

### Machine maintenance data

- Provides maintenance status of separate machines operating at multiple sites.
- Maintenance data is also relayed to KOBELCO service personnel, for more efficient planning of periodic servicing.

Model	Serial No.	Hour Meter	Engine Oil
SK135SRLC-3/SK140SRL	<a href="#">YH07-09721</a>	0.38/0.35	734 Hr
SK135SRLC-3/SK140SRL	<a href="#">YH07-09789</a>	0.38/0.35	73 Hr
SK210LC-9	<a href="#">YQ13-10454</a>	0.8/0.7	960 Hr
SK210LC-9	<a href="#">YQ13-10481</a>	0.8/0.7	549 Hr
SK75SR-	<a href="#">YT08-30374</a>		

Maintenance

### Warning alerts

- This system warns an alert if an anomaly is sensed, preventing damage that could result in machine downtime.

### Alarm information can be received through E-mail

- Alarm information or maintenance notice can be received through E-mail, using a computer or cell phone.



Messages displayed when the machine returns to the set area.

### Daily/Monthly reports

- Operational data downloaded onto a computer helps in formulating daily and monthly reports.

## Security system

### Engine start alarm

- The system can be set an alarm if the machine is operated outside designated time.

Engine start alarm outside prescribed work time

### Area alarm

- It can be set an alarm if the machine is moved out of its designated area to another location.

Alarm for outside of reset area

## Engine

Model	HINO J05E-UM
Type	Direct injection, water cooled, 4-cycle, 4-cylinder diesel engine with intercooler turbo-charger Stage V
No. of cylinders	4
Bore and stroke	112 mm x 130 mm
Displacement	5.123 L
Rated power output	119kW/2,000 min <sup>-1</sup> (ISO 9249)
	124kW/2,000 min <sup>-1</sup> (ISO 14396)
Max. torque	640N·m/1,600 min <sup>-1</sup> (ISO 9249)
	660N·m/1,600 min <sup>-1</sup> (ISO 14396)

## Hydraulic System

Pump	
Type	Two variable displacement piston pumps + One gear pump
Max. discharge flow	2 x 220L/min, 1 x 20L/min
	Extra gear pump 1 x 55 L/min
Relief valve setting	
Boom, arm and bucket	34.3 MPa {350 kgf/cm <sup>2</sup> }
Power Boost	37.8 MPa {385 kgf/cm <sup>2</sup> }
Travel circuit	34.3 MPa {350 kgf/cm <sup>2</sup> }
Swing circuit	29.0 MPa {296 kgf/cm <sup>2</sup> }
Control circuit	5.0 MPa {50 kgf/cm <sup>2</sup> }
Pilot control pump	Gear type
Main control valves	8-spool
Oil cooler	Air cooled type

## Swing System

Swing motor	Axial piston motor
Brake	Hydraulic; locking automatically when the swing control lever is in the neutral position
Parking brake	Oil disk brake, hydraulic operated automatically
Swing speed	12.6 min <sup>-1</sup> {rpm}
Swing torque	71.5 kN·m
Tail swing radius	1,680mm
Min. front swing radius	2,370mm

## Attachments

Backhoe bucket and arm combination

Use	Backhoe bucket					
	Normal digging					
Bucket capacity	ISO heaped	m <sup>3</sup>	0.51	0.7	0.8	0.93
	struck	m <sup>3</sup>	0.39	0.52	0.59	0.67
Opening width	With side cutters	mm	870	1,080	1,160	1,330
	Without side cutters	mm	770	980	1,060	1,230
No. of bucket teeth			3	5	5	5
Bucket weight		kg	520	630	650	710
Combinations	2.87 m standard arm		○	○	◎	△

◎ Standard ○ Recommend △ Loading only

## Travel System

Travel motors	2 x axial piston, two-speed motors	
Travel brakes	Hydraulic brake per motor	
Parking brakes	Oil disk brake per motor	
Travel shoes	SK225SR	46 each side
	SK230SRLC	49 each side
Travel speed	5.8 / 3.5 km/h	
Drawbar pulling force	229 kN {23,300kgf} (ISO 7464)	
Gradeability	70% {35°}	

## Cab & Control

Cab	
All-weather, sound-suppressed steel cab mounted on the silicon-sealed viscous mounts and equipped with a heavy, insulated floor mat.	
Control	
Two hand levers and two foot pedals for travel	
Two hand levers for excavating and swing	
Electric rotary-type engine throttle	

## Boom, Arm & Bucket

Boom cylinders	120 mm x 1,355 mm
Arm cylinder	130 mm x 1,406 mm
Bucket cylinder	110 mm x 1,064 mm

## Refilling Capacities & Lubrications

Fuel tank	330 L
Cooling system	24 L
Engine oil	20.5 L
Travel reduction gear	2 x 5.0 L
Swing reduction gear	2.7 L
Hydraulic oil tank	114 L tank oil level
	230 L hydraulic system
DEF/Urea tank	33.9 L





## Working Ranges

Unit: m

Boom	5.62m
Arm	2.87m
Range	2.87m
a- Max. digging reach	9.70
b- Max. digging reach at ground level	9.53
c- Max. digging depth	6.58
d- Max. digging height	10.58
e- Max. dumping clearance	7.71
f- Min. dumping clearance	2.98
g- Max. vertical wall digging depth	5.95
h- Min. swing radius	2.37
i- Horizontal digging stroke at ground level	5.03
j- Digging depth for 2.4 m (8') flat bottom	6.37
Bucket capacity ISO heaped m <sup>3</sup>	0.80

## Digging Force (ISO 6015)

Unit: kN

Arm length	2.87m
Bucket digging force	120 132*
Arm crowding force	88 96.8*

\*Power Boost engaged.

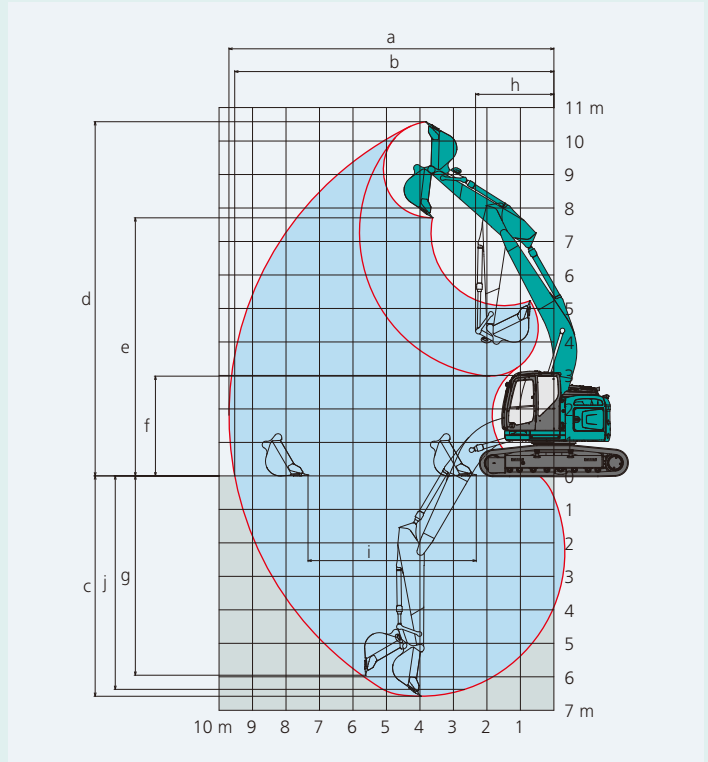

## Dimensions

Arm length	2.87m
A Overall length	SK225SR 8,690 SK230SR <sub>LC</sub> 8,830
B Overall height (to top of boom)	3,080
C Overall width of crawler	SK225SR 2,800 SK230SR <sub>LC</sub> 2,990
D Overall height (to top of cab)	3,150
E Ground clearance of rear end*	1,030
F Ground clearance*	445
G Tail swing radius	1,680

Unit: mm

G' Distance from center of swing to rear end	1,680
H Tumbler distance	SK225SR 3,370 SK230SR <sub>LC</sub> 3,660
I Overall length of crawler	SK225SR 4,170 SK230SR <sub>LC</sub> 4,450
J Track gauge	SK225SR 2,200 SK230SR <sub>LC</sub> 2,390
K Shoe width	600
L Overall width of upperstructure	2,990

\*Without including height of shoe lug.

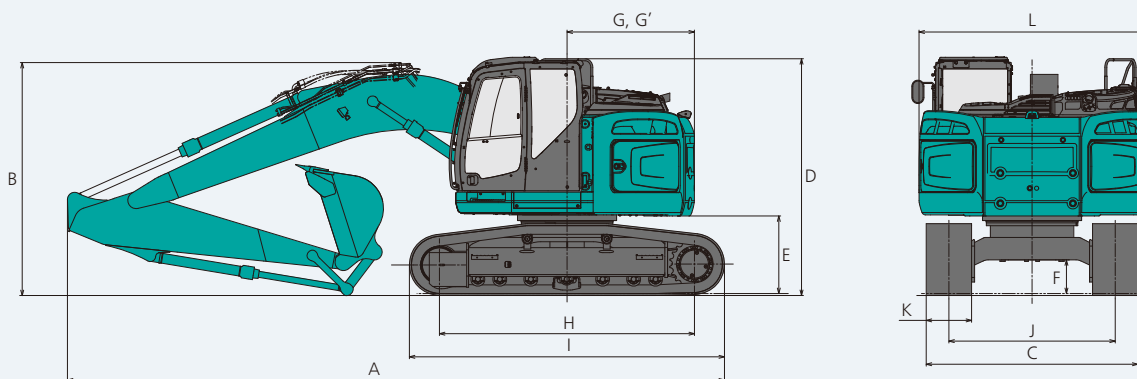

## Operating Weight & Ground Pressure

In standard trim, with standard boom, 2.87 m arm, and 0.8 m<sup>3</sup> ISO heaped bucket

Shaped		Triple grouser shoes (even height)		
Shoe width	mm	600*1	700	790
Overall width of upper structure	mm	2,990	2,990	2,990
Overall width of crawler	SK225SR mm	2,800	2,900	2,990
	SK230SR <sub>LC</sub> mm	2,990	3,090	3,180
Ground pressure	SK225SR kPa	52	45	40
	SK230SR <sub>LC</sub> kPa	49	43	38
Operating weight	SK225SR kg	23,100	23,500	23,700
	SK230SR <sub>LC</sub> kg	23,500	24,000	24,200

\*1. Dozer is only applicable for 600mm shoe specification.

# Lifting Capacities

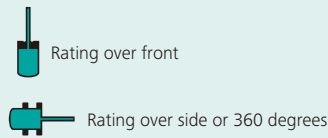
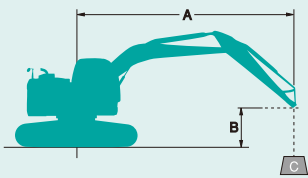

A: Reach from swing centerline to arm top  
 B: Arm top height above/below ground  
 C: Lifting capacities in Kilograms  
 Bucket: Without bucket  
 Relief valve setting: 37.8 Mpa {385 kgf/cm<sup>2</sup>}

## Mono Boom Specifications

SK225SR		Arm: 2.87m Bucket: Without Counterweight: 5,910kg Shoe: 600 mm HEAVY LIFT														
B	A	1.5 m		3.0 m		4.5 m		6.0 m		7.5 m		At Max. Reach		Radius		
		Rating over front	Rating over side or 360 degrees	Rating over front	Rating over side or 360 degrees	Rating over front	Rating over side or 360 degrees	Rating over front	Rating over side or 360 degrees	Rating over front	Rating over side or 360 degrees	Rating over front	Rating over side or 360 degrees			
9.0m	kg													*3,930	*3,930	3.99m
7.5m	kg					*5,320	*5,320							*3,220	*3,220	5.97m
6.0m	kg					*5,810	*5,810	*5,350	4,470					*2,990	*2,990	7.11m
4.5m	kg			*9,260	*9,260	*7,790	6,750	*6,590	4,310	*4,270	3,010			*2,950	2,800	7.81m
3.0m	kg					*9,430	6,210	6,470	4,080	4,580	2,910			*3,040	2,530	8.18m
1.5m	kg					9,680	5,720	6,200	3,840	4,460	2,800			*3,260	2,430	8.25m
G.L.	kg			*6,430	*6,430	9,370	5,460	6,020	3,680	4,370	2,720			*3,670	2,470	8.05m
-1.5m	kg	*6,680	*6,680	*10,560	10,200	9,280	5,390	5,950	3,620	4,350	2,700			4,310	2,680	7.55m
-3.0m	kg	*10,930	*10,930	*12,280	10,390	*9,200	5,450	6,000	3,660					5,180	3,200	6.67m
-4.5m	kg			*8,190	*8,190	*6,230	5,690							*5,000	4,620	5.24m

SK225SR		Arm: 2.87m Bucket: Without Counterweight: 5,910kg+1,400kg Shoe: 600 mm HEAVY LIFT														
B	A	1.5 m		3.0 m		4.5 m		6.0 m		7.5 m		At Max. Reach		Radius		
		Rating over front	Rating over side or 360 degrees	Rating over front	Rating over side or 360 degrees	Rating over front	Rating over side or 360 degrees	Rating over front	Rating over side or 360 degrees	Rating over front	Rating over side or 360 degrees	Rating over front	Rating over side or 360 degrees			
9.0m	kg													*3,930	*3,930	3.99m
7.5m	kg					*5,320	*5,320							*3,220	*3,220	5.97m
6.0m	kg					*5,810	*5,810	*5,350	5,100					*2,990	*2,990	7.11m
4.5m	kg			*9,260	*9,260	*7,790	7,660	*6,590	4,940	*4,270	3,490			*2,950	*2,950	7.81m
3.0m	kg					*9,430	7,120	7,290	4,710	5,190	3,390			*3,040	2,960	8.18m
1.5m	kg					*10,770	6,630	7,030	4,470	5,070	3,280			*3,260	2,850	8.25m
G.L.	kg			*6,430	*6,430	10,630	6,370	6,850	4,310	4,980	3,200			*3,670	2,910	8.05m
-1.5m	kg	*6,680	*6,680	*10,560	*10,560	10,550	6,300	6,770	4,240	*4,960	3,180			*4,420	3,150	7.55m
-3.0m	kg	*10,930	*10,930	*12,280	12,050	*9,200	6,370	*6,820	4,290					*5,740	3,750	6.67m
-4.5m	kg			*8,190	*8,190	*6,230	*6,230							*5,000	*5,000	5.24m

SK230SRLC		Arm: 2.87m Bucket: Without Counterweight: 5,910kg Shoe: 600 mm HEAVY LIFT														
B	A	1.5 m		3.0 m		4.5 m		6.0 m		7.5 m		At Max. Reach		Radius		
		Rating over front	Rating over side or 360 degrees	Rating over front	Rating over side or 360 degrees	Rating over front	Rating over side or 360 degrees	Rating over front	Rating over side or 360 degrees	Rating over front	Rating over side or 360 degrees	Rating over front	Rating over side or 360 degrees			
9.0m	kg													*3,930	*3,930	3.99m
7.5m	kg					*5,320	*5,320							*3,220	*3,220	5.97m
6.0m	kg					*5,810	*5,810	*5,350	5,010					*2,990	*2,990	7.11m
4.5m	kg			*9,260	*9,260	*7,790	7,600	*6,590	4,850	*4,270	3,390			*2,950	*2,950	7.81m
3.0m	kg					*9,430	7,040	*7,300	4,610	5,220	3,290			*3,040	2,870	8.18m
1.5m	kg					*10,770	6,540	7,130	4,370	5,100	3,180			*3,260	2,760	8.25m
G.L.	kg			*6,430	*6,430	10,980	6,270	6,940	4,200	5,010	3,100			*3,670	2,810	8.05m
-1.5m	kg	*6,680	*6,680	*10,560	*10,560	*10,660	6,200	6,870	4,140	*4,960	3,080			*4,420	3,060	7.55m
-3.0m	kg	*10,930	*10,930	*12,280	12,190	*9,200	6,270	*6,820	4,180					*5,740	3,650	6.67m
-4.5m	kg			*8,190	*8,190	*6,230	*6,230							*5,000	*5,000	5.24m

SK230SRLC		Arm: 2.87m Bucket: Without Counterweight: 5,910kg+1,400kg Shoe: 600 mm HEAVY LIFT														
B	A	1.5 m		3.0 m		4.5 m		6.0 m		7.5 m		At Max. Reach		Radius		
		Rating over front	Rating over side or 360 degrees	Rating over front	Rating over side or 360 degrees	Rating over front	Rating over side or 360 degrees	Rating over front	Rating over side or 360 degrees	Rating over front	Rating over side or 360 degrees	Rating over front	Rating over side or 360 degrees			
9.0m	kg													*3,930	*3,930	3.99m
7.5m	kg					*5,320	*5,320							*3,220	*3,220	5.97m
6.0m	kg					*5,810	*5,810	*5,350	*5,350					*2,990	*2,990	7.11m
4.5m	kg			*9,260	*9,260	*7,790	*7,790	*6,590	5,510	*4,270	3,890			*2,950	*2,950	7.81m
3.0m	kg					*9,430	8,010	*7,300	5,270	*5,860	3,800			*3,040	*3,040	8.18m
1.5m	kg					*10,770	7,510	*7,960	5,030	5,750	3,680			*3,260	3,210	8.25m
G.L.	kg			*6,430	*6,430	*11,190	7,240	7,830	4,860	5,660	3,600			*3,670	3,270	8.05m
-1.5m	kg	*6,680	*6,680	*10,560	*10,560	*10,660	7,170	7,760	4,800	*4,960	3,580			*4,420	3,550	7.55m
-3.0m	kg	*10,930	*10,930	*12,280	*12,280	*9,200	7,240	*6,820	4,840					*5,740	4,230	6.67m
-4.5m	kg			*8,190	*8,190	*6,230	*6,230							*5,000	*5,000	5.24m

- Do not attempt to lift or hold any load that is greater than these lift capacities at their specified lift point radius and heights. Weight of all accessories must be deducted from the above lift capacities.
- Lift capacities are based on machine standing on level, firm, and uniform ground. User must make allowance for job conditions such as soft or uneven ground, out of level conditions, side loads, sudden stopping of loads, hazardous conditions, experience of personnel, etc.
- Arm top defined as lift point.
- The above lifting capacities are in compliance with ISO 10567. They do not exceed 87% of hydraulic lifting capacity or 75% of tipping load. Lifting capacities marked with an asterisk (\*) are limited by hydraulic capacity rather than tipping load.
- Operator should be fully acquainted with the Operator's and Maintenance Instructions before operating this machine. Rules for safe operation of equipment should be adhered to at all times.
- Lift capacities apply to only machine as originally manufactured and normally equipped by KOBELCO CONSTRUCTION MACHINERY CO., LTD.

## STANDARD EQUIPMENT

### ENGINE

- Engine, HINO J05E-UM engine with turbocharger and intercooler, Stage V certified
- Automatic engine deceleration
- Auto idle Stop(AIS)
- Batteries (2 x12V - 92 Ah)
- Starting motor (24 V - 5kW), 60 A alternator
- Automatic engine shut-down for low engine oil pressure
- Engine oil pan drain valve
- Double element air cleaner

### CONTROL

- Working mode selector (H-mode, S-mode and ECO-mode)
- Power Boost
- Heavy lift
- Gear pump
- Extra N&B piping (proportional hand controlled)
- Quick Hitch piping

### SWING SYSTEM & TRAVEL SYSTEM

- Swing rebound prevention system
- Straight propel system
- Two-speed travel with automatic shift down
- Sealed & lubricated track links
- Grease-type track adjusters
- Automatic swing brake

### MIRRORS, LIGHTS & CAMERA

- Rear view mirrors, rearview camera
- Two front working lights

### CAB & CONTROL

- Two control levers, pilot-operated
- Horn, electric
- Integrated left-right slide-type control box
- Cab light (interior)
- Coat hook
- Large cup holder
- Detachable two-piece floor mat
- Suspension seat
- Seatbelt
- Headrest
- Handrails
- Heater and Defroster
- Intermittent windshield wiper with double-spray washer
- Sky light
- Top guard (ISO 10262 : 1998)
- Tinted safety glass
- Pull-type front window and removable lower front window
- Easy-to-read multi-display monitor
- Automatic air conditioner
- Emergency escape hammer
- Radio, AM/FM stereo with speaker
- Pressure release switch
- DPF switch
- 12V converter
- Hydraulic fluid filter clog detector
- Remote machine monitoring system "GEOSCAN"
- Travel alarm
- Lower under cover

## OPTIONAL EQUIPMENT

- Wide range of shoes
- Front-guard protective structure (may interfere with bucket action)
- Add-on counterweight (+ 1400kg)
- Additional cab two light
- Air suspension seat
- Rain visor (may interfere with bucket action)
- Additional track guide
- Dozer blade (only for SK225SR with 600mm shoe)
- Right side view camera

Note: Standard and optional equipment may vary. Consult your KOBELCO dealer for specifics.

Note: This catalog may contain attachments and optional equipment that are not available in your area. And it may contain photographs of machines with specifications that differ from those of machines sold in your areas. Please consult your nearest KOBELCO distributor for those items you require. Due to our policy of continuous product improvements all designs and specifications are subject to change without advance notice. Copyright by **KOBELCO CONSTRUCTION MACHINERY CO., LTD.** No part of this catalog may be reproduced in any manner without notice.

**KOBELCO CONSTRUCTION MACHINERY CO., LTD.**

5-15, Kitashinagawa 5-chome, Shinagawa-ku, Tokyo 141-8626 JAPAN  
Tel: +81 (0) 3-5789-2146 Fax: +81 (0) 3-5789-2135  
[www.kobelco-kenki.co.jp/english\\_index.html](http://www.kobelco-kenki.co.jp/english_index.html)

Inquiries To: