

KOBELCO

SK500_{LC}



We Save You Fuel
Achieving a Low-Carbon Society

Power Meets Efficiency



SK500_{LC}

Higher fuel
efficiency
means
"Efficiency"

Increase in
productivity
means
"Power"

To urban centers, and to mines around the world. Kobelco's all-out innovation brings you durable earth-friendly construction machinery that's equal to any task, at sites all over the planet. Increased power and even greater fuel economy bring higher efficiency to any project. Kobelco SK500LC machines are also more durable than ever, able to withstand the rigors of the toughest job sites. It all adds up to new levels of value that are a step ahead of the times. While focusing on the global environment of the future, Kobelco offers next-generation productivity to meet the need for lower life cycle costs and exceed the expectations of customers the world over.



Evolution Continues, with Improved Fuel Efficiency.

Hydraulic System: Revolutionary Technology Saves Fuel

Arm Interflow System NEW

When lowering the boom, this system uses the downward force generated by the boom's weight to push fluid to the shovel arm. This greatly reduces the need to apply power from outside the system.

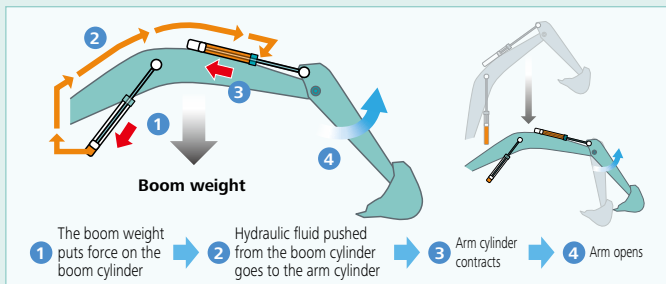

Hydraulic Circuit Reduces Energy Loss

We have made every effort to enhance fuel efficiency by minimizing hydraulic pressure resistance, improving the hydraulic line layout to control friction resistance loss and minimizing valve resistance.

Improved hydraulic piping is an effective means of reducing pressure loss.

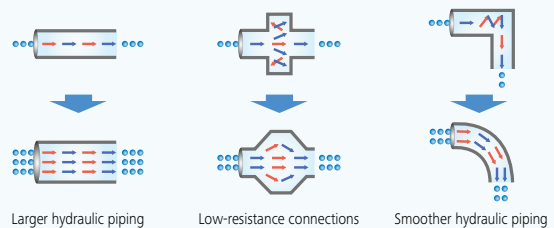

In Pursuit of Improved Fuel Efficiency

Operation Mode

Fuel consumption is lower in H-mode/S-mode/ECO-mode in comparison with the previous model (Generation 9).

■ Compared to previous models

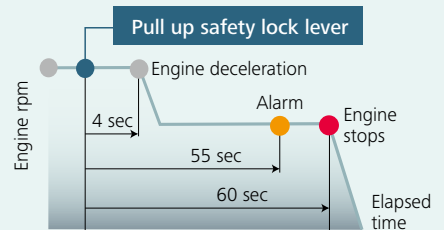
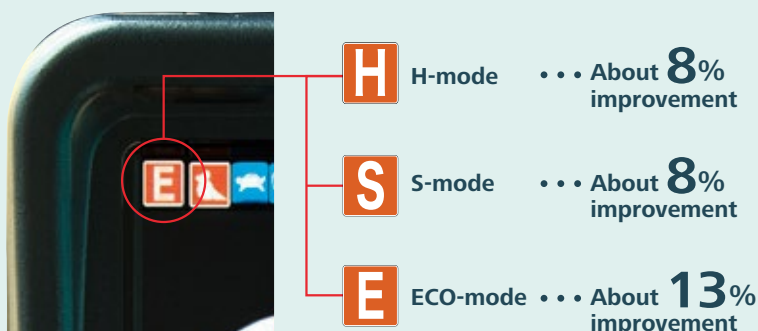

AIS (Auto Idle Stop)

If the boarding/disembarking lever is left up, the engine will stop automatically. This eliminates wasteful idling during standby, saving fuel and reducing CO₂ emissions as well.

Higher fuel efficiency means "Efficiency"

The new arm interflow system more efficiently controls hydraulic fluid flow, and significant reduction of in-line resistance and pressure loss boosts fuel efficiency. The electronic-control common-rail engine features high-pressure fuel injection and multiple injection with improved precision. It is fitted with an EGR cooler which greatly reduce PM and NOx emissions and meets TIERIII Standards.



Built to operate in tough working environment

Hydraulic Drive for Engine Cooling Fan; **NEW** Independent Oil Cooler Fan

Hydraulic drive optimizes the cooling fan rotation speed to improve fuel economy and reduce noise. Also, the independent oil cooler fan better matches cooling to the hydraulic oil temperature, for optimal oil temperature control.

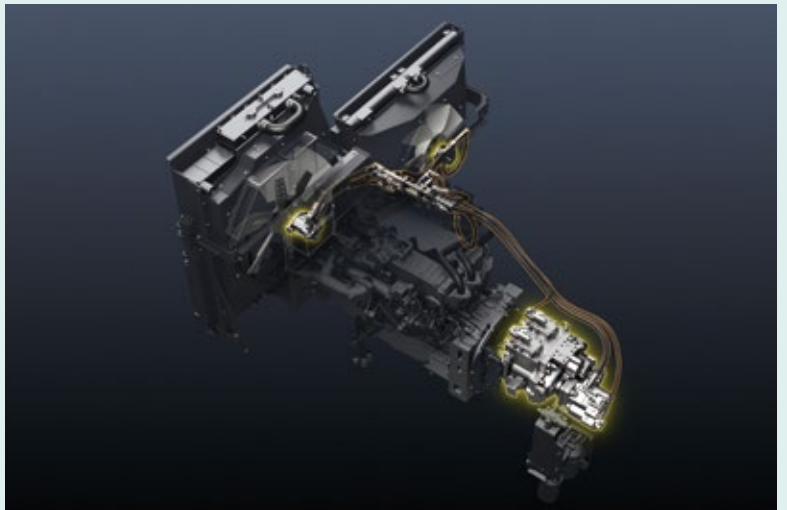

Pursuing maximum fuel efficiency

Common rail system

High-pressure injection atomizes the fuel, and more precise injection improves combustion efficiency. This also contributes to better fuel economy.

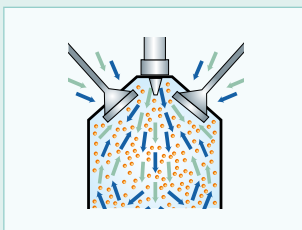

EGR cooler

While ensuring sufficient oxygen for combustion, cooled emission gases are mixed with the intake air and recirculated into the engine. This reduces oxygen content and lowers combustion temperature.

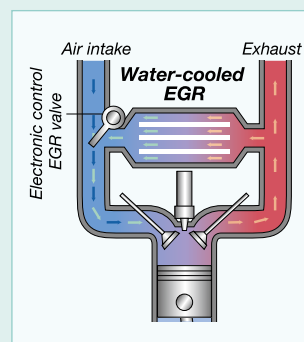

More Power and Higher Efficiency

The highly efficient hydraulic system minimizes fuel consumption while maximizing power. With nimble movement and ample digging power, this excavator promises to improve your job productivity.

Superior Digging Force

■ Max. Bucket Digging Force

Normal: **267 kN**
With power boost: **292 kN**

■ Max. Arm Crowding Force

Normal: **203 kN**
With power boost: **222 kN**



Get More Done Faster with Superior Operability

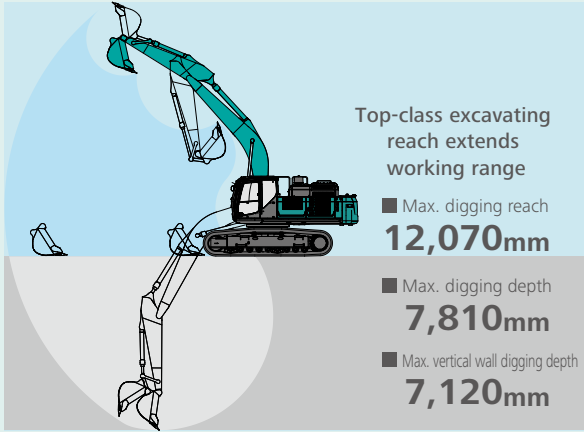

Top-class excavating reach extends working range

■ Max. digging reach
12,070mm

■ Max. digging depth
7,810mm

■ Max. vertical wall digging depth
7,120mm

Values are for HD arm (3.45m)

Piping for Quick Hitch (except ME specification)

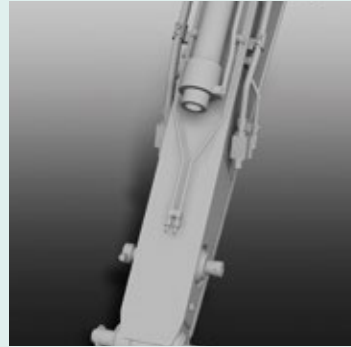

A quick hitch hydraulic line, which speeds up attachment changes.

A Light Touch on the Lever NEW Means Smoother, Less Tiring Work



It takes 25%* less effort to work the operation lever, which reduces fatigue over long working hours or continued operations.

*Compared to SK500LC-9

Top Class Traveling Force

Powerful traveling force and pulling force deliver plenty of speed when climbing slopes or negotiating bad roads, and the agility to change direction swiftly and smoothly.



■ Drawbar Pulling Force: **415kN**

Operator-friendly Features Include Controls that Are Easy to See, Easy to Use



Multi-Display in Color

Brilliant colors and graphic displays are easy to recognize on the LCD multi-display in the console. The display shows fuel consumption, maintenance intervals, and more.

- 1 Analog gauge provides an intuitive reading of fuel level and engine water temperature
- 2 Green indicator light shows low fuel consumption during operation
- 3 PM accumulation display (left)/Urea level gauge (right)
- 4 Fuel consumption/Switch indicator for rear camera images
- 5 Digging mode switch
- 6 Monitor display switch

One-Touch Attachment Mode Switch

A simple flick of a switch converts the hydraulic circuit and flow amount to match attachment changes. Icons help the operator to confirm the proper configuration at a glance.

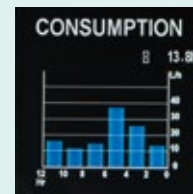

Fuel consumption

Maintenance

	INTERVAL	REMAINING TIME	EXCHANGE DATE
ENGINE OIL	500	498	--/--
FUEL FILTER	500	498	--/--
HYD. FILTER	1000	998	--/--
HYD. OIL	5000	4998	--/--

Maintenance

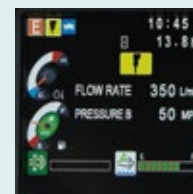

Digger mode



Nibbler mode

Increased Power, with Enhanced Durability to Maintain the Machine's Value

Improved Filtration System Reliability

Clean, contaminant-free fuel and hydraulic fluid are essential to stable performance. The improved filtration systems reduce the risk of mechanical trouble and enhance longevity and durability.

Hydraulic Fluid Filter ^{NEW}

Recognized as the best in the industry, our premium fine filter separates out even the smallest particles. New cover prevents contamination when changing filters.



Hydraulic Fluid Filter Clog ^{NEW} Detector

Pressure sensors at the inlet and outlet of the hydraulic fluid filter monitor differences in pressure to determine the degree of clogging. If the difference in pressure exceeds a predetermined level, a warning appears on the multi-display, so any contamination can be removed from the filter before it reaches the hydraulic fluid reservoir.

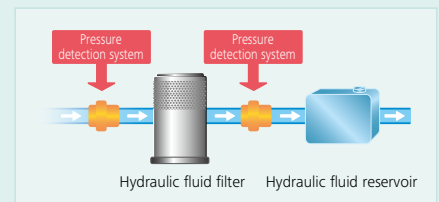

Double-Element Air Cleaner

The large-capacity element features a double-filter structure that keeps the engine running clean even in industrial environments.



Fuel Filter ^{NEW}

The pre-filter, with built-in water separator maximizes filtering performance.

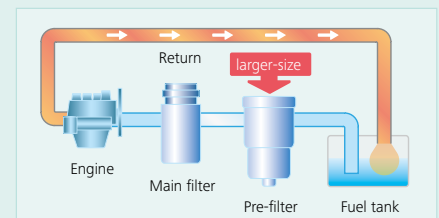

Increase in
productivity
means
"Power"

Structural design increases strength,
while eliminating hydraulic problems.
Enhanced durability takes
productivity to a new level.



Increased Filtering Capacity for Hydraulic Oil **NEW**

Two filters are installed for returning hydraulic oil, to curb clogging and increase the durability and reliability of the hydraulic equipment.



Pump Drain Filter **NEW**

Newly installed pump drain filter boosts pump reliability.



Pilot Filter

A new cartridge-type pilot filter simplifies maintenance.



Comfortable Cab Is Now Safer than Ever

A work environment that is quieter and more comfortable. A cab that puts the operator first is key to improved safety.



Comfort

Super-Airtight Cab



The high level of air-tightness keeps dust out of the cab.

Quiet Inside

The high level of air-tightness ensures a quiet, comfortable cabin interior.

Low Vibration

Coil springs absorb small vibrations, and high suspension mounts filled with silicone oil reduce heavy vibration. The long stroke achieved by this system provides excellent protection from vibration.

Twice the stroke of a conventional mount

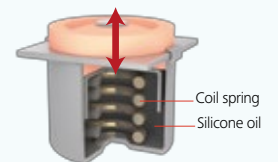

Broad View Liberates the Operator

The front window features one large piece of glass without a center pillar on the right side for a wide, unobstructed view.

Air Conditioner NEW Register behind the Seat



The large air-conditioner has registers on the back pillars that blow from behind and to the right and left of the operator's seat. They can be adjusted to put a direct flow of cool/warm air on the operator, which means a more comfortable operating environment.

More Comfortable Seat Means Higher Productivity



Seat suspension absorbs vibration



Seat recliner can be pushed back flat



Double slides allow adjustment for optimum comfort



Large Cab Is Easy to Get In and Out of

The expanded cab provides plenty of room for a large door, more headroom and smoother entry and exit.

Interior Equipment Adds to Comfort and Convenience



AM/FM Bluetooth®(hands-free) radio



USB connector/12V power outlet



Spacious storage tray



Large cup holder

**Bluetooth® is a registered trademark of the Bluetooth SIG Inc.

Safety

ROPS Cab

ROPS (Roll-Over-Protective Structure)-compliant cab clears ISO standards (ISO-12117-2: 2008) and ensures greater safety for the operator should the machine tip over.



TOP Guard is fitted as standard.

Expanded Field of View for Greater Safety

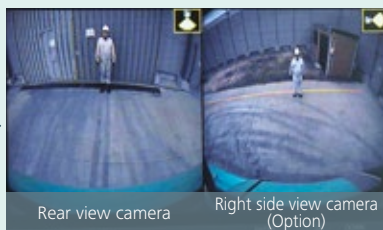

Rear view camera Right side view camera (Option)

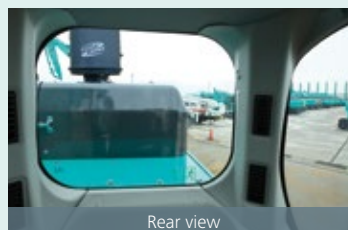

Rear view

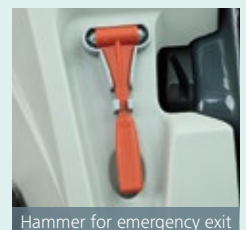

Hammer for emergency exit

Right Side Camera Fitted as Option

In addition to the existing rear-view camera, a camera for the right side is fitted as option for easy safety checks all around the machine.

Rear view shows the area directly behind the cab.

GEOSCAN

Excavator Remote Monitoring System

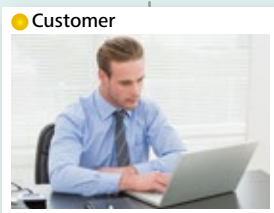
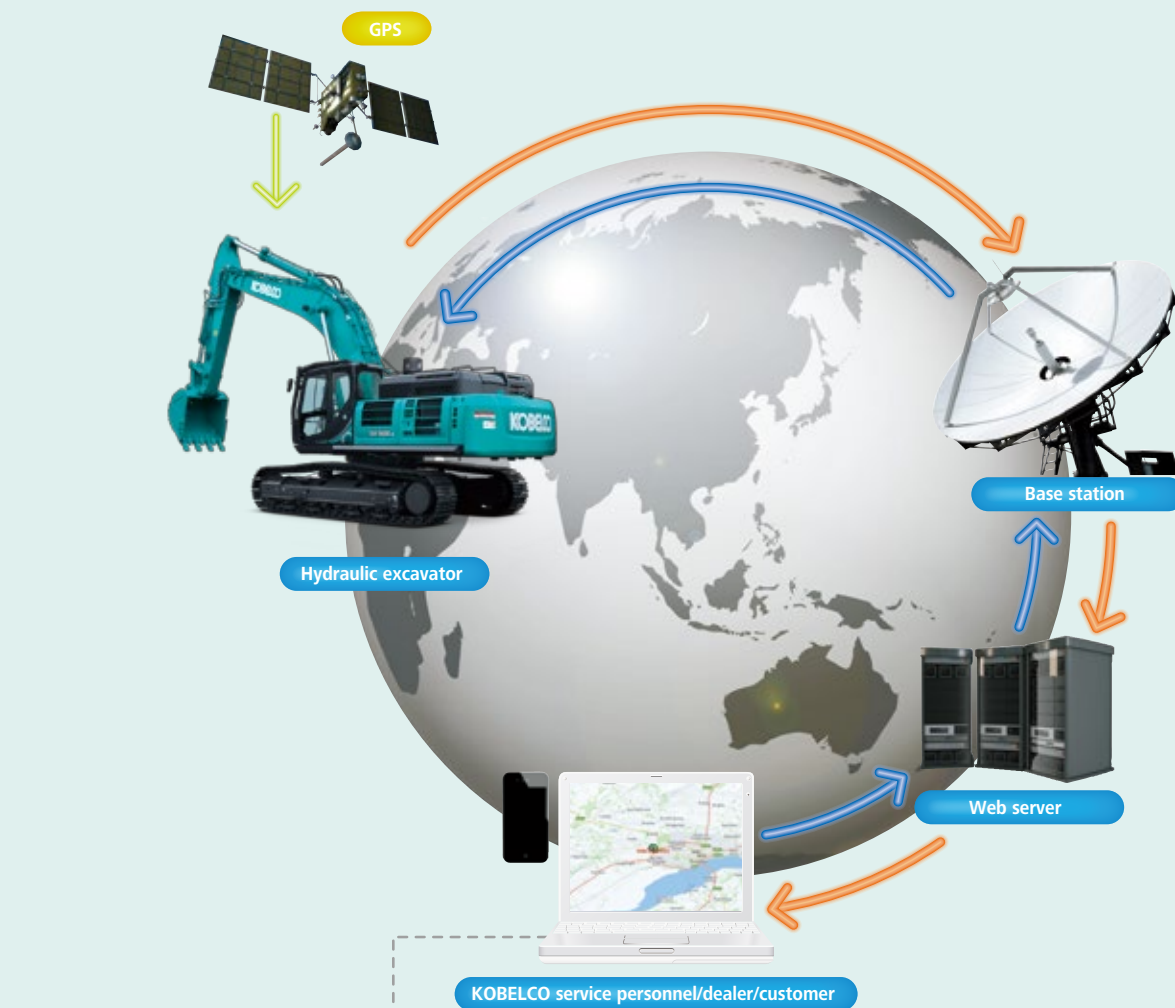

Remote Monitoring for Peace of Mind

GEOSCAN uses satellite communication and internet to relay data, and therefore can be deployed in areas where other forms of communication are difficult.

When a hydraulic excavator is fitted with this system, data on the machine's operation, such as operating hours, location, fuel consumption, and maintenance status can be obtained remotely.

Direct Access to Operational Status

Location Data

• Accurate location data can be obtained even from sites where communications are difficult.

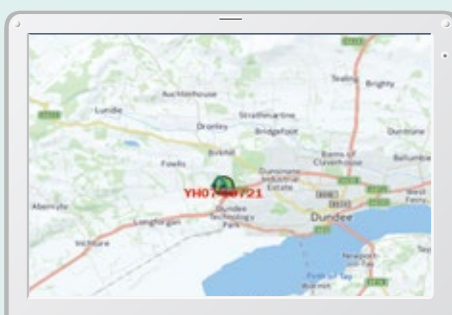

Latest location

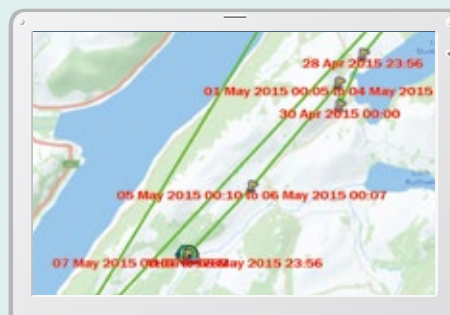

Location records

Period: 11 Apr, 2015 to 10 May, 2015		Search	
Type of Operation	Working Hrs		Ratio
Total Working Hrs	169 Hrs	100 %	
Digging Hrs	72.2 Hrs	43 %	
Traveling Hrs	18.3 Hrs	11 %	
Idle Hrs	15.9 Hrs	9 %	
Opt Att Hrs	62.5 Hrs	37 %	
Crane Mode Hrs	0 Hrs	0 %	

Work data

Operating Hours

- A comparison of operating times of machines at multiple locations shows which locations are busier and more profitable.
- Operating hours on site can be accurately recorded, for running time calculations needed for rental machines, etc.

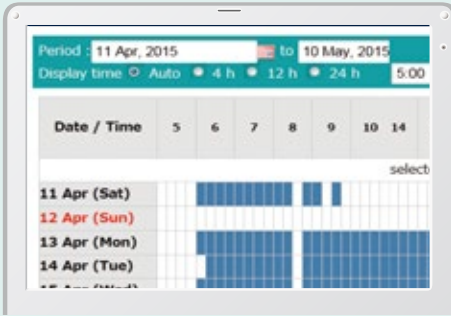

Daily report

Fuel Consumption Data

- Data on fuel consumption and idling times can be used to indicate improvements in fuel consumption.

Work mode	Working Hrs	Total Fuel Consumption
H mode	2:06	24.5 L
S mode	0:00	0.0 L
E mode	169:19	1489.7 L
TOTAL	171:25	1514.2 L

Fuel consumption

Graph of Work Content

- The graph shows how working hours are divided among different operating categories, including digging, idling, traveling and optional operations.

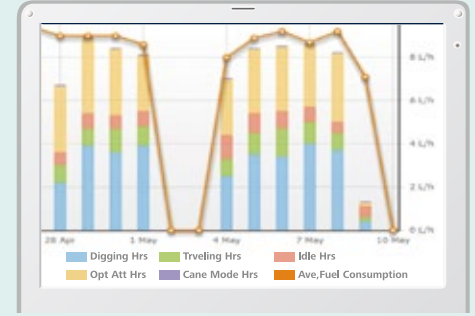

Work status

Maintenance Data and Warning Alerts

Machine Maintenance Data

- Provides maintenance status of separate machines operating at multiple sites.
- Maintenance data is also relayed to KOBELCO service personnel, for more efficient planning of periodic servicing.

Model	Serial No.	Hour Meter	Engine Oil
SK135SRCL-3/SK140SRL	YH07-09721	0.38/0.35	734 Hr
SK135SRCL-3/SK140SRL	YH07-09789	0.38/0.35	73 Hr
SK210LC-9	YQ13-10454	0.8/0.7	960 Hr
SK210LC-9	YQ13-10481	0.8/0.7	549 Hr
SK75SR-	YT08-30374		

Maintenance

Warning Alerts

- This system warns an alert if an anomaly is sensed, preventing damage that could result in machine downtime.

Alarm Information Can Be Received through E-mail

- Alarm information or maintenance notice can be received through E-mail, using a computer or cell phone.



Alarm messages can be received on mobile device.

Daily/Monthly Reports

- Operational data downloaded onto a computer helps in formulating daily and monthly reports.

Security System

Engine Start Alarm

- The system can be set an alarm if the machine is operated outside designated time.

Engine start alarm outside prescribed work time

Area Alarm

- It can be set an alarm if the machine is moved out of its designated area to another location.

Alarm for outside of reset area



Easy, On-the-Spot Maintenance NEW

There is ample space in the engine compartment for a mechanic to do maintenance work inside. The distance between steps are lower so entry and exit is easier. And the mechanic can work in comfort, without contortions or unnatural body positions. Finally, the hood is lighter and easier to raise and lower.



Step/Hand rail



Double-element air cleaner

Ground Level Access

Laid out for easy access to radiator and cooling system elements.



Left side

Maintenance Work, Daily Checks, Etc., Can Be Done from Ground Level

The layout allows for easy access from the ground for many daily checks and regular maintenance tasks.



Engine oil filter



Pilot filter



Pump drain filter



Right side



Pre-filter with water separator

- ① Engine oil filter
- ② Pilot filter
- ③ Pump drain filter
- ④ Pre-filter with water separator

Efficient Maintenance Keeps the Machine in Peak Operating Condition



Machine Information Display Function

Examples of displaying maintenance information

- Displays only the maintenance information that's needed, when it's needed
- Self-diagnostic function provides early-warning detection and display of electrical system malfunctions
- Service-diagnostic function makes it easier to check the status of the machine
- Record function for previous breakdowns including irregular and transient malfunction

More Efficient Maintenance Inside the Cab

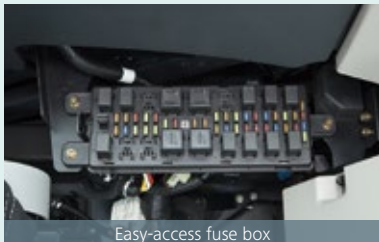

Easy-access fuse box

More finely differentiated fuses make it easier to locate malfunctions.

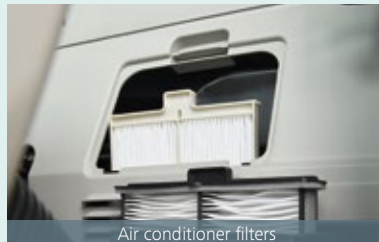

Air conditioner filters

Internal and external air conditioner filters can be easily removed without tools for cleaning.

Easy Cleaning



Crawler frame

Special sloped crawler side frame design is easily cleaned of mud.



Detachable two-piece floor mat

Detachable two-piece floor mat with handles for easy removal. A floor drain is located under the floor mat.

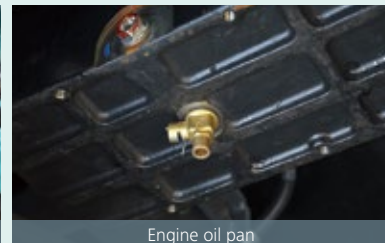

Engine oil pan

Engine oil pan equipped with drain valve.

Long-life hydraulic oil:
5,000
hours

Long-Interval Maintenance

Long-life hydraulic oil reduces cost and labor.

Replacement cycle:
1,000
hours

Highly Durable Premium-fine Filter

The high-capacity hydraulic oil filter incorporates glass fiber with superior cleaning power and durability.



Engine

Model	HINO P11C-UP
Type	Water-cooled, 4cycle 6cylinder direct injection type diesel engine with intercooler turbo-charger
No. of cylinders	6
Bore and stroke	122 mm × 150 mm
Displacement	10.52 L
Rated power output	Net 257 kW/1,850 min ⁻¹ (ISO 14396 : without fan)
Max. torque	Net 1,400 N·m/1,400 min ⁻¹ (ISO 14396 : without fan)

Hydraulic System

Pump	
Type	Two variable displacement pumps + One gear pump
Max. discharge flow	2 × 370 L/min, 1 × 63.5 L/min Extra gear pump 1 × 60 L/min
Relief valve setting	
Excavating circuits (main)	31.4 Mpa
Power boost	34.3 Mpa
Travel circuit	34.3 Mpa
Swing circuit	26.0 Mpa
Pilot control circuit	5.0 Mpa
Pilot control pump	Gear type
Main control valve	8-spool
Oil cooler	Air cooled type

Swing System

Swing motor	Axial piston motor
Parking brake	Wet multiple plate, hydraulic operated automatically
Swing speed	7.6 min ⁻¹
Swing torque	183 kN·m
Tail swing radius	3,800 mm
Min front swing radius	5,140 mm

Attachments

Backhoe bucket and combination

Use			Backhoe bucket				
			Heavy digging	Normal digging	Light digging	Mass Excavating	
Bucket capacity	ISO heaped	m ³	1.9	2.1	2.1	2.4	3.4
Struck		m ³	1.4	1.5	1.5	1.7	2.5
Opening width	With side cutters	mm	1,590	1,660	1,750	1,980	1,990
	Without side cutters	mm	1,510	1,580	1,630	1,860	1,870
No. of teeth			4	5	5	5	6
Bucket weight		kg	2,150	2,270	1,560	1,690	2,340
Combination	3.0m short arm		○	◎	◎	△	×
	3.45m standard arm		◎	△	△	×	×
	4.04m long arm		△	×	×	×	×
	6.3m ME boom and 2.4 ME arm		×	×	×	×	○*

◎ Standard ○ Recommend △ Loading only × Not recommended

*Mass Excavating specs should be used for light-digging.

Travel System

Travel motors	2 x axial-piston, two-step motors
Travel brakes	Hydraulic brake per motor
Parking brakes	Wet multiple plate
Travel shoes	50 each side
Travel speed (high/low)	5.4/3.4 km/h
Drawbar pulling force	415 kN
Gradeability	70 % (35 deg)
Ground clearance	510 mm

Cab & Control

Cab

All-weather, sound-suppressed steel cab mounted on the high suspension mounts filled with silicone oil and equipped with a heavy, insulated floor mat.

Control

Two hand levers or two foot pedals for forward and backward operations of each track independently.

Boom, Arm & Bucket

Boom cylinders	170 mm × 1,590 mm
Arm cylinder	190 mm × 1,970 mm
Bucket cylinder	160 mm × 1,410 mm

Refilling Capacities & Lubrications

Fuel tank	638 L
Cooling system	47.4 L
Engine oil	42.5 L
Travel reduction gear	2×15 L
Swing reduction gear	2×5 L
Hydraulic oil tank	371 L tank oil level
	631 L hydraulic system



Working Ranges

Unit: m

Boom	Arm	ME 6.3m		7.0 m	
		ME 2.4Arm	Short 3.0Arm	Standard 3.45Arm	Long 4.04Arm
Range					
a- Max. digging reach		10.88	11.77	12.07	12.61
b- Max. digging reach at ground level		10.63	11.54	11.84	12.4
c- Max. digging depth		6.48	7.36	7.81	8.4
d- Max. digging height		10.92	11.16	10.93	11.14
e- Max. dumping clearance		6.92	7.72	7.58	7.79
f- Min. dumping clearance		3.11	3.22	2.77	2.18
g- Max. vertical wall digging depth		5.58	6.68	7.12	7.5
h- Min. swing radius		4.78	5.28	5.14	5.21
i- Horizontal digging stroke at ground level		3.59	5.21	6.1	7.07
j- Digging depth for 2.4 m (8') flat bottom		6.31	7.21	7.67	8.27
Bucket capacity ISO heaped m ³		3.4	2.1	1.9	1.6

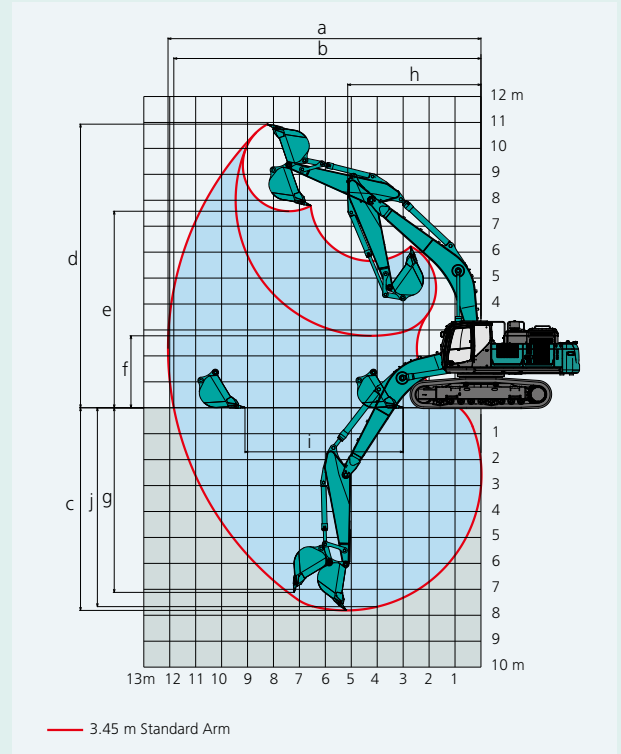

Digging Force (ISO 6015)

Unit: kN

Arm length	ME 2.4Arm	Short 3.0Arm	Standard 3.45Arm	Long 4.04Arm
Bucket digging force	288/312*	266/291*	267/292*	289/264*
Arm crowding force	247/270*	223/244*	203/222*	198/181*

*Power Boost engaged.



Dimensions

Unit: mm

Arm length	ME 2.4Arm	Short 3.0Arm	Standard 3.45Arm	Long 4.04Arm
A Overall length	11,910	12,200	12,140	12,190
B Overall height (to top of boom)	4,240	3,770	3,570	3,720
C Overall width	3,350			
D Overall height (to top of cab)	3,380			
E Ground clearance of rear end*	1,260*			
F Ground clearance*	510*			
G Tail swing radius	3,880	3,800		
G' Distance from center of swing to rear end	3,880	3,800		
H Tumbler distance	4,400			
I Overall length of crawler	5,450			
J Track gauge	2,750			
K Shoe width	600			
L Overall width of upperstructure	3,110			

*Excluding height of shoe lug.

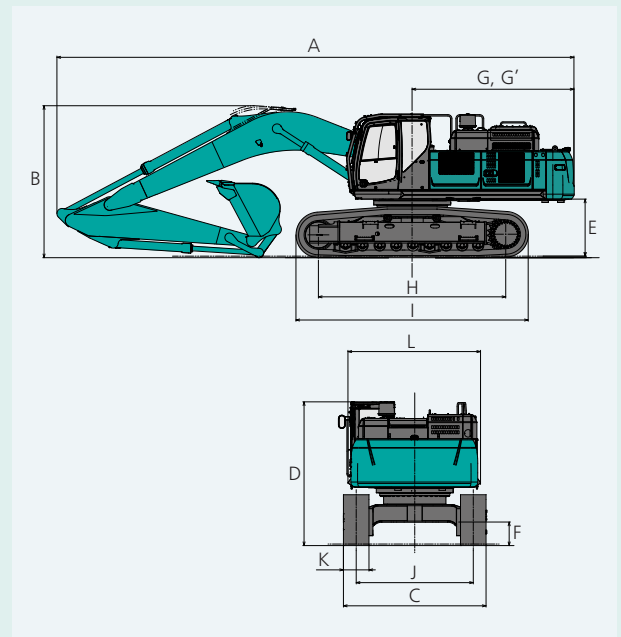

Operating Weight & Ground Pressure

In standard trim, with standard boom, 3.45 m arm, and 1.9 m³ ISO heaped bucket

Shaped	Triple grouser shoes (even height)		
Shoe width	mm	600	800
Overall width of crawler	mm	3,350	3,550
Ground pressure	kPa	86	66
Operating weight	kg	50,200	51,600

In standard trim, with 6.3 m ME boom, 2.4 m ME arm, and 3.4 m³ ISO heaped bucket

Shaped	Triple grouser shoes (even height)		
Shoe width	mm	600	800
Overall width of crawler	mm	3,350	3,550
Ground pressure	kPa	89	68
Operating weight	kg	51,600	53,000

Lift Capacities

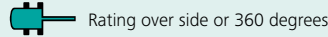
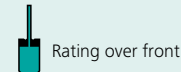
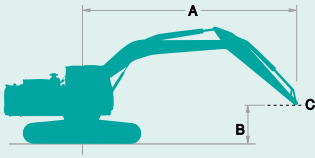

A: Reach from swing centerline to arm top
 B: Arm top height above/below ground
 C: Lift point
 Bucket: Without bucket
 Relief valve setting: 34.3 MPa

SK500LC-10		Boom: 7.0 m Arm: 3.45 m Bucket: without, Counterweight: 9,800 kg Shoe: 600 mm (Heavy Lift)														
A \ B		3.0 m		4.5 m		6.0 m		7.5 m		9.0 m		At Max. Reach		Radius		
9.0m	kg													*10,330	*10,330	7.76m
7.5m	kg													*10,080	8,730	8.85m
6.0m	kg													*9,890	7,530	9.59m
4.5m	kg			*18,050	*18,050	*13,820	*13,820	*11,760	10,860	*10,630	8,210	*9,980	6,840	*10,330	6,480	10.04m
3.0m	kg			*22,790	21,260	*16,120	14,180	*13,020	10,340	*11,310	7,930	*10,330	6,480	*10,330	6,480	10.26m
1.5m	kg			*14,790	*14,790	*18,000	13,410	*14,160	9,890	*11,960	7,670	10,250	6,360	10,250	6,360	10.25m
G.L.	kg			*18,080	*18,080	*19,060	12,970	*14,930	9,580	12,220	7,490	10,510	6,490	10,510	6,490	10.01m
-1.5m	kg	*13,040	*13,040	*25,670	19,610	*19,230	12,800	*15,140	9,440	12,150	7,420	11,240	6,910	11,240	6,910	9.53m
-3.0m	kg	*22,230	*22,230	*24,140	19,830	*18,440	12,870	*14,550	9,480			11,800	7,790	11,800	7,790	8.76m
-4.5m	kg	*28,120	*28,120	*21,140	20,300	*16,340	13,180	*12,370	9,790			11,980	9,590	11,980	9,590	7.63m

SK500LC-10		Boom: 7.0 m Arm: 3.0 m Bucket: without, Counterweight: 9,800 kg Shoe: 600 mm (Heavy Lift)														
A \ B		3.0 m		4.5 m		6.0 m		7.5 m		9.0 m		At Max. Reach		Radius		
9.0m	kg													*11,290	*11,290	7.36m
7.5m	kg													*10,930	9,230	8.51m
6.0m	kg													*10,850	7,910	9.27m
4.5m	kg			*19,670	*19,670	*14,670	*14,670	*12,350	10,770	*11,150	8,170	*10,910	7,170	*10,910	7,170	9.74m
3.0m	kg					*16,870	14,020	*13,530	10,280	*11,730	7,920	10,860	6,790	10,860	6,790	9.96m
1.5m	kg					*18,550	13,340	*14,560	9,880	*12,280	7,700	10,760	6,690	10,760	6,690	9.95m
G.L.	kg			*13,600	*13,600	*19,340	12,990	*15,180	9,620	12,280	7,550	11,070	6,860	11,070	6,860	9.70m
-1.5m	kg	*10,220	*10,220	*23,790	19,820	*19,210	12,910	*15,180	9,530	*12,260	7,550	11,810	7,360	11,810	7,360	9.21m
-3.0m	kg	*22,180	*22,180	*23,330	20,100	*18,090	13,040	*14,240	9,640			11,970	8,400	11,970	8,400	8.41m
-4.5m	kg	*25,400	*25,400	*19,810	*19,810	*15,410	13,430					11,760	10,580	11,760	10,580	7.22m

SK500LC-10		Boom: 7.0 m Arm: 4.04 m Bucket: without, Counterweight: 9,800 kg Shoe: 600 mm (Heavy Lift)																	
A \ B		1.5 m		3.0 m		4.5 m		6.0 m		7.5 m		9.0 m		10.5 m		At Max. Reach		Radius	
9.0m	kg																*8,740	*8,740	8.47m
7.5m	kg																*8,300	7,800	9.48m
6.0m	kg																*8,160	6,810	10.17m
4.5m	kg																*9,900	8,210	10.60m
3.0m	kg					*20,700	*20,700	*14,970	14,340	*12,210	10,370	*10,660	7,890	*9,760	6,190	*8,490	5,900	10.80m	
1.5m	kg					*19,900	*19,900	*17,090	13,450	*13,480	9,850	*11,410	7,590	9,800	6,030	*8,980	5,780	10.79m	
G.L.	kg			*6,590	*6,590	*19,630	19,480	*18,470	12,870	*14,440	9,470	*11,990	7,360	9,680	5,930	9,590	5,810	10.57m	
-1.5m	kg	*8,670	*8,670	*12,720	*12,720	*24,690	19,290	*19,000	12,600	*14,890	9,260	11,950	7,230			10,170	6,200	10.11m	
-3.0m	kg	*14,910	*14,910	*19,830	*19,830	*24,790	19,400	*18,630	12,580	*14,660	9,230	*11,760	7,260			10,990	6,890	9.40m	
-4.5m	kg			*29,250	*29,250	*22,430	19,780	*17,130	12,790	*13,330	9,410					11,300	8,230	8.35m	
-6.0m	kg					*18,040	*18,040	*13,620	13,320							11,240	11,240	6.81m	

SK500LC-10		ME Boom: 6.3 m ME Arm: 2.4 m Bucket: without, Counterweight: 11,200 kg Shoe: 600 mm (Heavy Lift)														
A \ B		3.0 m		4.5 m		6.0 m		7.5 m		At Max. Reach		At Max. Reach		Radius		
9.0m	kg													*14,020	*14,020	5.63m
7.5m	kg													*11,920	*11,920	7.07m
6.0m	kg													*11,010	10,730	7.97m
4.5m	kg													*10,660	9,520	8.52m
3.0m	kg													*10,690	8,950	8.77m
1.5m	kg													*11,080	8,840	8.76m
G.L.	kg													*11,920	9,180	8.48m
-1.5m	kg					*24,790	21,990	*18,920	14,380	*14,670	10,740	*13,360	10,140	13,360	10,140	7.90m
-3.0m	kg	*27,610	*27,610	*21,650	*21,650	*16,570	14,700					*12,960	12,250	12,960	12,250	6.95m

Notes:

- Do not attempt to lift or hold any load that is greater than these lift capacities at their specified lift point radius and heights. Weight of all accessories must be deducted from the above lift capacities.
- Lift capacities are based on machine standing on level, firm, and uniform ground. User must make allowance for job conditions such as soft or uneven ground, out of level conditions, side loads, sudden stopping of loads, hazardous conditions, experience of personnel, etc.
- Arm top defined as lift point.
- The above lift capacities are in compliance with ISO 10567. They do not exceed 87% of hydraulic lift capacity or 75% of tipping load. Lift capacities marked with an asterisk (*) are limited by hydraulic capacity rather than tipping load.
- Operator should be fully acquainted with the Operator's and Maintenance Instructions before operating this machine. Rules for safe operation of equipment should be adhered to at all times.
- Lift capacities apply to only machine as originally manufactured and normally equipped by KOBELCO CONSTRUCTION MACHINERY CO., LTD.

STANDARD EQUIPMENT

ENGINE

- Engine, HINO P11C-UP, diesel engine with turbocharger and intercooler
- Automatic engine deceleration
- Auto Idle Stop (AIS)
- Batteries (2 x 12V - 112Ah)
- Starting motor (24V - 6 kW), 60 amp alternator
- Automatic engine shut-down for low engine oil pressure
- Engine oil pan drain cock
- Double element air cleaner

CONTROL

- Working mode selector (H-mode, S-mode and ECO-mode)
- Power Boost
- Heavy lift
- Boom and arm safety valve
- N&B piping (except ME specification)

SWING SYSTEM & TRAVEL SYSTEM

- Swing rebound prevention system
- Straight propel system
- Two-speed travel with automatic shift down
- Sealed & lubricated track links
- Grease-type track adjusters
- Automatic swing brake
- Travel alarm

HYDRAULIC

- Arm regeneration system
- Auto warm up system
- Aluminum hydraulic oil cooler
- Hydraulic fluid filter clog detector
- Quick hitch piping (except ME specification)

MIRRORS, LIGHTS & CAMERAS

- Three Rearview mirrors, Bottom clearance mirror
- Three front working lights
- Rear view camera

CAB & CONTROL

- Two control levers, pilot-operated
- Horn, electric
- Cab light (interior)
- Luggage tray
- Large cup holder
- Detachable two-piece floor mat
- Headrest
- Handrails
- Intermittent windshield wiper with double-spray washer
- Skylight
- Tinted safety glass
- Pull-up type front window and removable lower front window
- Easy-to-read multi-display color monitor
- Automatic air conditioner
- Emergency escape hammer
- Air suspension seat
- Radio (AUX & Bluetooth®)
- USB pin
- TOP guard (ISO 10262:1998)
- GEOSCAN
- Lower Under Cover
- 12V outlet

OPTIONAL EQUIPMENT

- Mass Excavator specification
- Various optional arms
- Wide range of shoes
- Additional track guide
- Two cab lights
- Mechanical suspension seat
- Rain visor (may interfere with bucket action)

- Cab guard
- Hydraulic pressure adjustment function for N&B piping
- Right-side view camera
- Multi control valve
- Extra piping (Applicable for 7.0m boom)
- N&B piping for ME specification
- Refueling pump

Note: Standard and optional equipment may vary. Consult your KOBELCO dealer for specifics. Bluetooth® is a registered trademark of the Bluetooth SIG Inc.

Note: This catalog may contain attachments and optional equipment that are not available in your area. And it may contain photographs of machines with specifications that differ from those of machines sold in your areas. Please consult your nearest KOBELCO distributor for those items you require. Specialist equipment is needed to use this machine in demolition work. Before using it please contact your KOBELCO dealer. Due to our policy of continuous product improvements all designs and specifications are subject to change without advance notice. Copyright by **KOBELCO CONSTRUCTION MACHINERY CO., LTD.** No part of this catalog may be reproduced in any manner without notice.

KOBELCO CONSTRUCTION MACHINERY CO., LTD.

5-15, Kitashinagawa 5-chome, Shinagawa-ku, Tokyo 141-8626 JAPAN
Tel: +81 (0) 3-5789-2146 Fax: +81 (0) 3-5789-2135
www.kobelcocm-global.com

KOBELCO is the corporate mark used by Kobe Steel on a variety of products and in the names of a number of Kobe Steel Group companies.

Inquiries To: