



TURBOFARMER MEDIUM DUTY TF33.9-115, TF33.9-115CS



MERLO

PERFORMANCE AND FEATURES	TF33.9-115	TF33.9-115CS	
PERFORMANCE			
Total unladen weight (kg)	6950	7100	
Maximum capacity (kg)	3300	3300	
Lifting height (m)	8,6	8,6	
Maximum reach (m)	5,8	5,8	
Maximum operating height (m)	6,1	6,1	
Maximum operating reach (m)	1,5	1,5	
Capacity at maximum height (kg)	1750	1750	
Capacity at maximum reach (kg)	550	550	
Lateral boom movement (mm)	-	-	
Tilting correction (%)	-	-	
Boom sections	3	3	
POWERTRAIN			
Turbo motor	Deutz TCD3.6	Deutz TCD3.6	
Displacement/cylinders	3600/4	3600/4	
Engine Power (kW/HP)	85/115	85/115	
Anti-pollution technology	TIER 4F, STAGE IV, SCR+DOC	TIER 4F, STAGE IV, SCR+DOC	
Reversible fan	●	●	
Maximum speed (km/h)	40	40	
Fuel tank (l)	85	85	
AdBlue tank (l)	12	12	
Hydrostatic transmission	● - 2V	● - 2V	
EPD	Top	Top	
Axles	Axial	Axial	
Reduction hub	Epicyclic	Epicyclic	
Machine brakes	Dry disc	Dry disc	
Automatic parking brake	●	●	
HYDRAULIC			
Hydraulic pump	LS+FS	LS+FS	
Flow rate/pressure (l/min – bar)	125-210	125-210	
Hydraulic tank	85	85	
Hydraulic outlet at the top of the boom	●	●	
Rear hydraulic outlets	○	○	
CAB			
Cab configuration	ECO	ECO	
MCDC	Complet	Complet	
FOPS LIV II cab	●	●	
ROPS cab	●	●	
Cab commands	Electronic joystick	Electronic joystick	
Tilting Cab	-	-	
Reverse shuttle	Dual reverse	Dual reverse	
CONFIGURATION			
Cab suspension	-	●	
Boom suspension	●	●	
Suspension on axles	-	-	
Work headlights on cab	●	●	
Sun blind	●	●	
Tac-lock	●	●	
Provision for a platform	○	○	
Two floating forks	●	●	
Inching-Control	●	●	
Four-wheel drive	●	●	
Four-wheel steering	●	●	
Three steering modes	●	●	
Standard tyres	405/70-24"	405/70-24"	
Optional tyres	-	-	
Stabilisers	-	-	
Turret rotation	-	-	
Type approval as an agricultural tractor	○	○	
Approval with PNEUMATIC braking	○	○	
Approval with HYDRAULIC braking	○	○	
PTO	-	-	
3-point linkage	-	-	

- Not Available. ● standard. ○ optional.

LOAD CHARTS

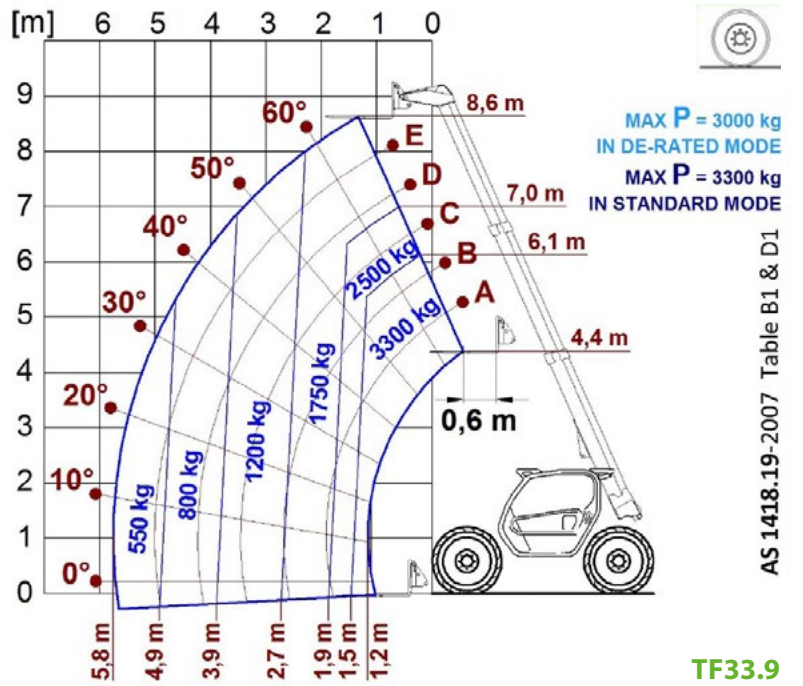

DIMENSIONS

	TF33.9		
A (mm)	4330		
B (mm)	990		
C (mm)	2740		
D (mm)	600		
E (mm)	3910		
F (mm)	380		
H (mm)	2250		
M (mm)	995		
P (mm)	2240		
R (mm)	4095		
S (mm)	4740		
Z (mm)	850		

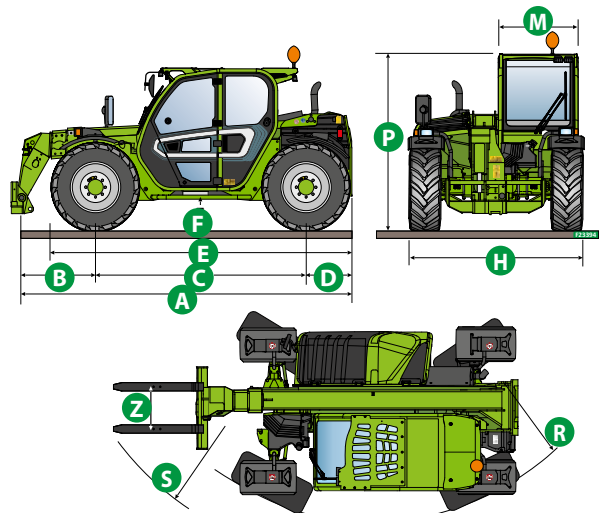



MERLO GROUP AUSTRALIA PTY LTD

27 Colin Jamieson Dve, Welshpool (Perth), WA 6106
Tel. (08) 9358 3110 - Fax (08) 9358 4110

120 Toongabbie Road, Girraween, NSW 2145
Tel. (02) 9688 0600

Tel:1300 657 325

info@merloaustralia.com.au
www.merloaustralia.com.au

Your Merlo dealer

DS_TF339_0720_AUS